



INSTALLATION GUIDE AND USER MANUAL

Sol-Ark 60K-3P-480V



COMMERCIAL & INDUSTRIAL
NORTH AMERICA



READ THE INSTRUCTIONS COMPLETELY BEFORE OPERATING THE EQUIPMENT

Check the utility voltage before turning ON the unit.

For proper operation, this unit **REQUIRES** closed-loop communications with a compatible high voltage battery. Visit www.sol-ark.com/battery-partners for a complete list of compatible high voltage batteries.

Verify voltage and the programmed “Grid Level” before connecting to the utility.



DISCLAIMER

UNLESS SPECIFICALLY AGREED TO IN WRITING:

Sol-Ark assumes no responsibility or liability for any damages, property loss, personal injury, or any adverse consequences resulting from improper use and installation of the product or the failure to adhere to the guidelines provided in this document. Users are expressly advised to follow the instructions and guidelines outlined in the documentation accompanying the product. Sol-Ark shall not be liable for any damages or losses incurred due to deviations from recommended usage, installation, or maintenance procedures. By using the product, users acknowledge their understanding of these disclaimers and agree to use the product at their own risk. Sol-Ark reserves the right to update or modify product information, specifications, and guidelines without prior notice.

Sol-Ark retains the right to final interpretation of this document and all related materials pertaining to this product. This document is subject to modifications, updates, revisions, or termination without prior notice. For the latest product information, please visit Sol-Ark’s official website. www.sol-ark.com

This manual is only for the **60K-3P-480V Hybrid Inverter**.

For support, contact:

(USA) +1 (972) 575-8875 ext. (2)

support@sol-ark.com

Table of Contents

IMPORTANT SAFETY INSTRUCTIONS.....	5
1. Sol-Ark: At a First Glance	6
1.1 General Description	7
1.2 Specifications	8
1.3 Connection Requirements	10
2. Installation.....	11
2.1 Mounting the Sol-Ark.....	11
2.2 Integrating Batteries.....	13
2.3 Battery Communications	14
2.4 Connecting PV Modules.....	15
2.5 Integrating a Generator	16
2.6 Grid Peak Shaving	16
2.7 Automatic Generator Start	16
2.8 Integrating Sensors and Accessories	17
2.9 Limit Sensors (CT sensors).....	19
2.10 Emergency Stop and Rapid Shutdown.....	21
2.11 Powering-up and Testing the Sol-Ark.....	22
2.12 Power Cycle Sequence.....	22
3. User Interface.....	23
3.1 LED Indicators	23
3.2 Main Menus	23
3.3 Basic Setup	25
3.4 Battery Setup	26
3.5 Limiter.....	28
3.6 Grid Setup.....	32
4. Installation Tips	34
4.1 Battery Charge Controller	34
4.2 Grid Compliance Settings	35
5. Parallel Systems	36
5.1 Before Enabling Parallel Operations	36
5.2 Parallel Systems Programming Sequence.....	37
5.3 Troubleshooting Phase Sequence.....	38
6. MySolArk: Remote Monitoring	39
6.1 MySolArk Setup Instructions.....	39
6.2 LED Indicator and troubleshooting	43
7. Wiring Diagrams	44
8. Troubleshooting Guide.....	52
8.1 Sol-Ark Error codes	54
9. Warranty Verification Checklist	55
10. GUI Screens	57

IMPORTANT SAFETY INSTRUCTIONS

SYMBOLS THAT APPEAR IN THIS DOCUMENT



WARNING: This symbol indicates information that, if ignored, could cause serious injury, equipment damage, or death.



CAUTION: This symbol indicates information that, if ignored, could result in minor injury or equipment damage.



NOTE: This symbol indicates relevant information that is not related to hazardous situations.

WARNINGS



Read this entire document before installing or using the Sol-Ark 60K-3P-480V inverter. Failure to follow any of the instructions or warnings in this document can result in electrical shock, serious injury, or death. Damage to the 60K-3P-480V inverter is also possible, potentially rendering it inoperable.



High Life Risk due to fire or electrocution - ONLY qualified persons should install the Sol-Ark inverter.



The system must have Ground connections and Neutral connections. Ground MUST be bonded to Neutral ONLY ONCE in the circuit.



Solar PV+/PV- are UNGROUNDED. Note, you may ground PV Racking/Mounts, but doing so directly to the Sol-Ark will likely result in damage in the case of a direct lightning strike to the PV array.



DO NOT connect the grid to the "LOAD" output terminal.



DO NOT reverse the polarity of batteries. Damage WILL occur.



DO NOT exceed 1,000Voc on any MPPT on the Sol-Ark.



DO NOT turn off the battery breaker if there is current flowing in or out of the battery in any amount.



DO NOT use impact drivers to tighten any fasteners on the Sol-Ark.



MUST use conduit (or double insulated wire) for AC wires entering/exiting Sol-Ark user area.



ALL terminals/breakers, including battery, MPPT, and AC Terminal Block inputs, should only have one conductor connected to them.

1. Sol-Ark: At a First Glance

INSPECT SHIPMENT

The box should include all items shown in the component guide. If there is damage or missing parts, immediately call the phone number (USA) +1 (972) 575-8875 Ext. 2.

COMPONENT GUIDE

The Sol-Ark 60K-3P-480V system includes the following components:

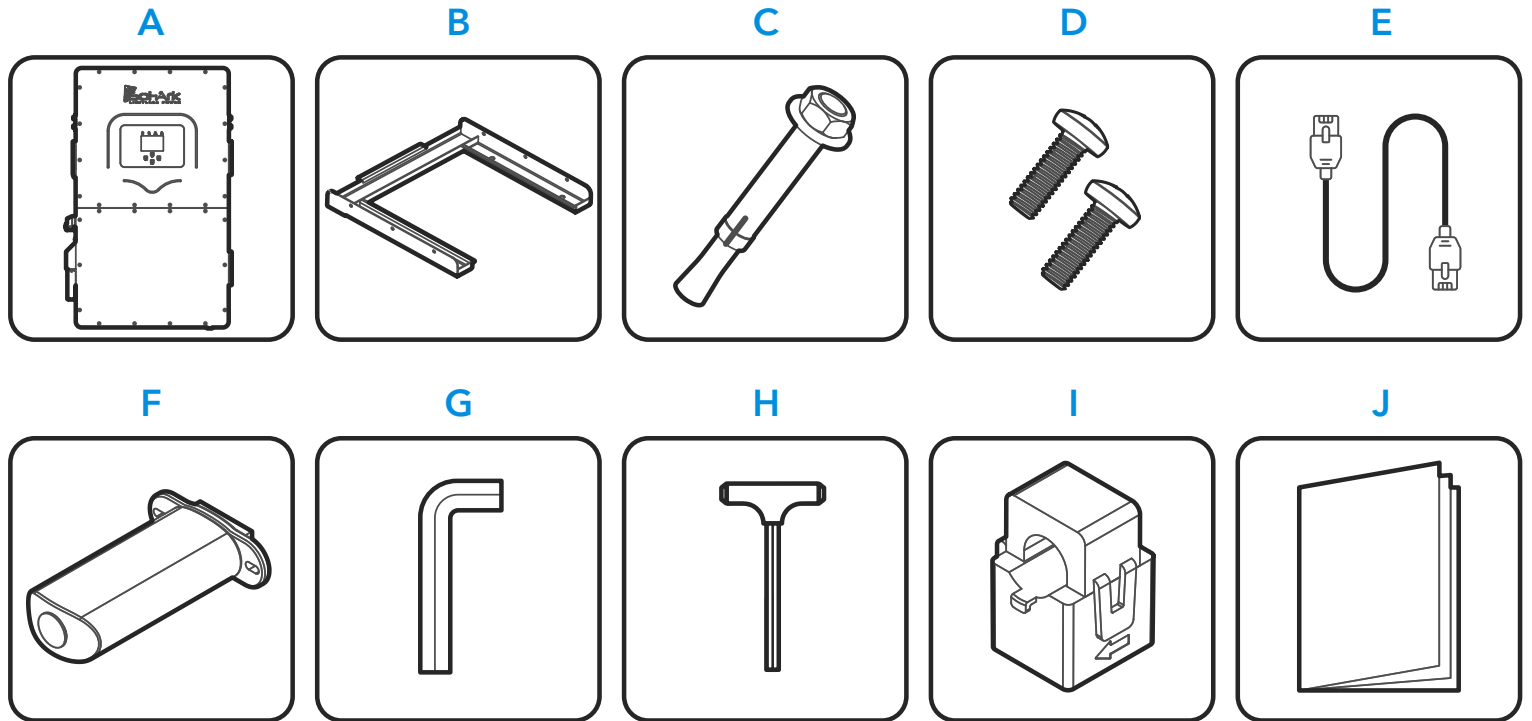

Component	Description	Quantity
A	Sol-Ark 60K-3P-480V inverter	1
B	French cleat	1
C	M12x60mm expanding anchors	4
D	M4x12mm screws	9
E	CAT 5E communication cable	1
F	Wi-Fi / Ethernet antenna (dongle)	1
G	3mm L-type hex key for front panel screws	1
H	8mm T-type hex key for AC terminals	1
I	300A (Ø2") Current transformers (CT sensors)	3
J	User manual	1

1.1 General Description

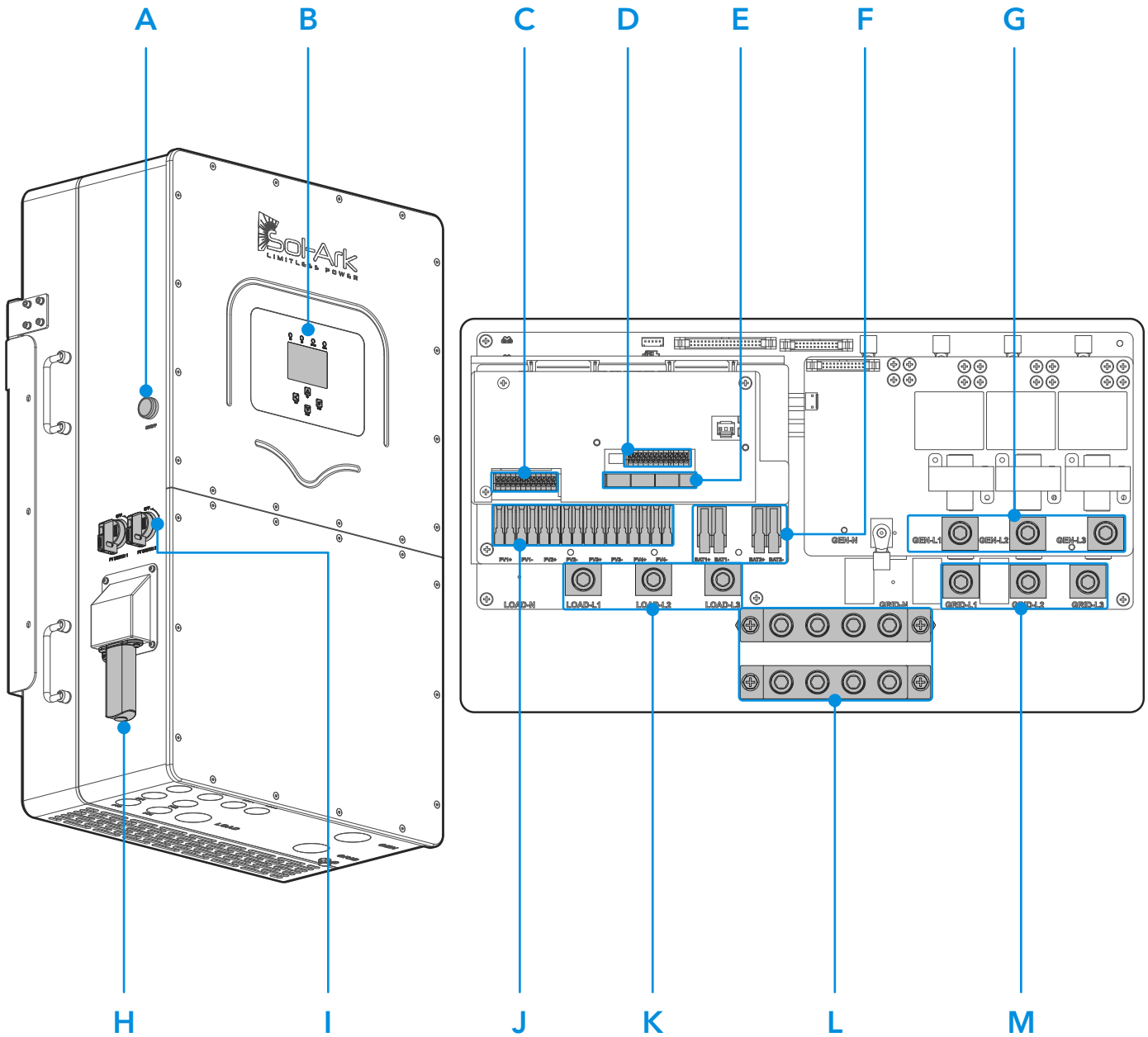

Component	Name	Component	Name
A	ON / OFF Button	H	Wi-Fi / Ethernet dongle
B	LCD touch screen	I	2x PV DC disconnects
C	Pin board 1 for sensors and accessories	J	4x MPPT inputs
D	Pin board 2 for sensors and accessories	K	(200A) LOAD terminal
E	Communication port board	L	NEUTRAL / GROUND Busbars
F	2x (50A) Battery port	M	(200A) GRID terminal
G	(200A) GEN terminal		

1.2 Specifications

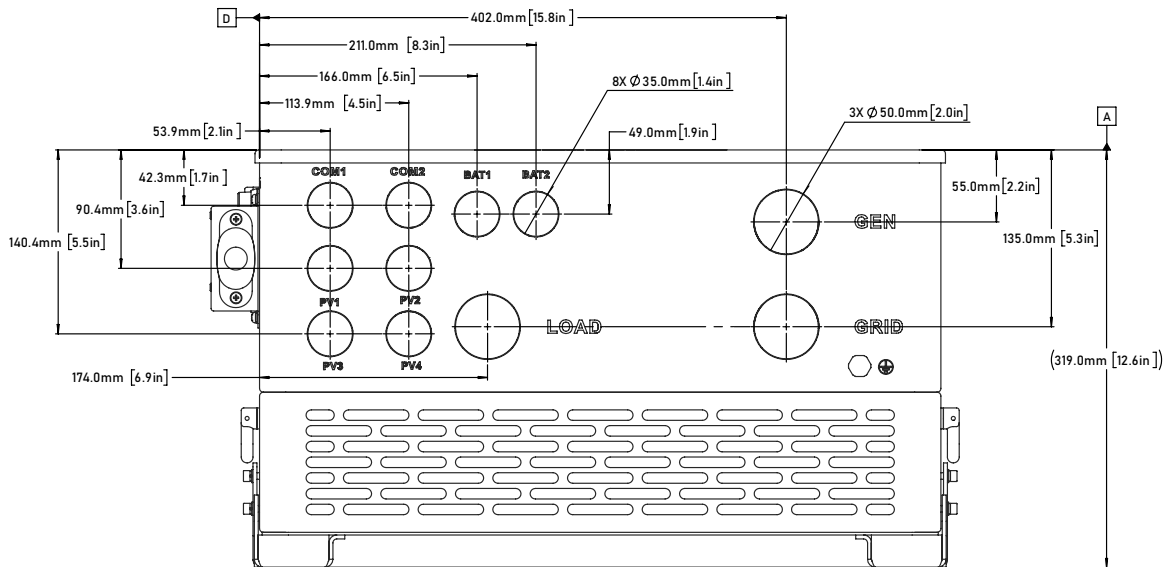
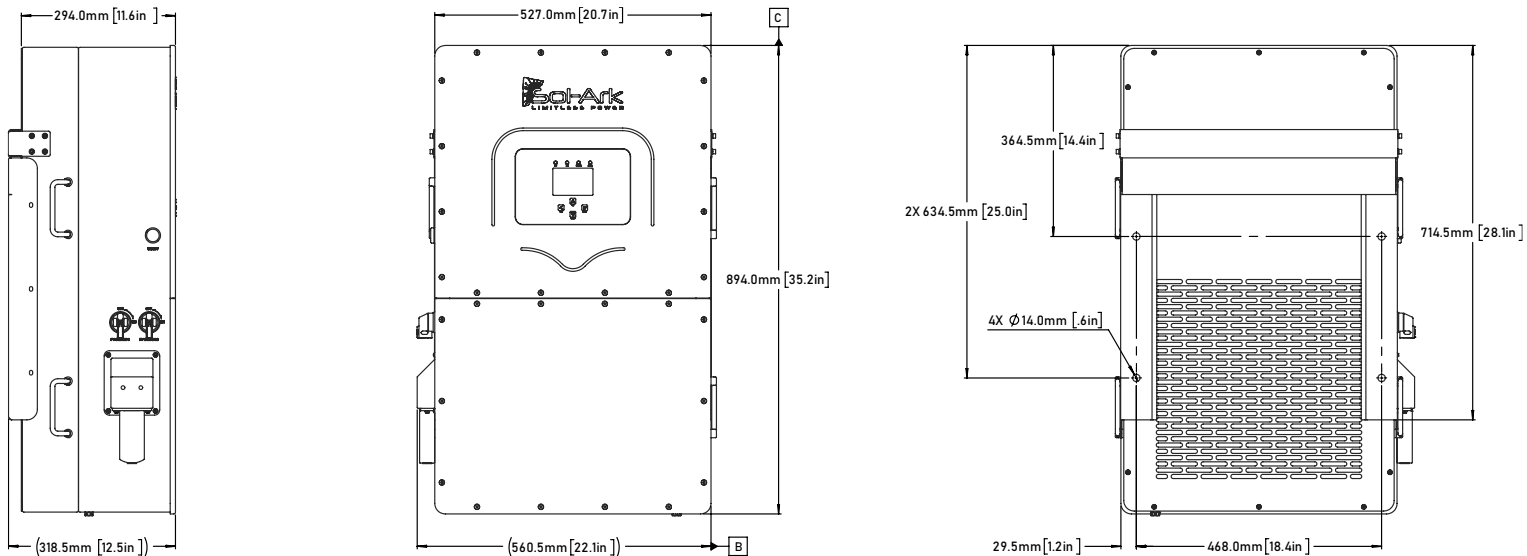

Temperature derating

DC: 90°C - 100°C. Shutdown @ 100°C

AC: 75°C - 82°C. Shutdown @ 82°C

SOL-ARK 60K-3P-480V TORQUE VALUES APPLICATION NOTE

Do not use impact drivers to tighten any fasteners on the Sol-Ark

Terminal / Breaker	Torque [in-lb]	Torque [Nm]
"LOAD"	62 in-lb	7 Nm
"GRID"	62 in-lb	7 Nm
"GEN"	62 in-lb	7 Nm
Neutral / Ground (Busbar)	62 in-lb	7 Nm
Cover Screws	15.5 in-lb	1.75 Nm
Battery Connection	Push-in Cage Clamp	Push-in Cage Clamp

DATASHEET

60K-480V

C&I Hybrid Inverter

Inverter Model Name:

60K-3P-480V

Sol-Ark Product SKU:

60K-3P-480V

Input Data (PV)	
Max. Allowed PV Power (STC)	78,000W
MPPT Voltage Range	150-850V
Startup Voltage	180V
Max. Input Voltage ¹	1,000V
Max. operating input current per MPPT	36A
Max. short circuit current per MPPT	55A
No. of MPP Trackers	4
No. of PV Strings per MPPT	2
Max. AC Coupled Input	60,000W
Output Data (AC)	
Nominal AC Voltage (3Φ)	277/480V
Grid Frequency	50 / 60Hz
Real Power, max continuous (3Φ)	60,000W
Max. Output Current	72.3A
Peak Apparent Power (10s, off-grid, 3Φ)	90,000VA
Max. Grid Passthrough Current (10min)	200A
Continuous Grid Passthrough Current	180A
Power Factor Output Range	+/- 0.8 adjustable
Backup Transfer Time	5ms (adjustable)
CEC Efficiency	96.5%
Max Efficiency	97.5%
Design (DC to AC)	Transformerless DC
Stackable	Up to 10 in parallel
Battery Input Data (DC)	
Battery Chemistry	Lithium iron phosphate
No. of Battery Inputs	2
Battery Input Terminal Rating	50A
Nominal DC Voltage	≥ 600V
Operating Voltage Range	160 - 800V
Battery Capacity Range	50 – 9900Ah
Max. Battery Charge / Discharge Current	100A (50A per input)
Charge Controller Type	3-Stage with Equalization
Grid to Battery Charging Efficiency	96.0%
Automatic Generator Start (AGS)	2 Wire Start - Integrated
BMS Communication ²	CANBus & RS485
General Data	
Dimensions (H x W x D)	894 x 528 x 295 mm (35.2 x 20.8 x 11.6 in)
Weight	80 Kg / 176 lb.
Enclosure	IP65 / NEMA 3R
Ambient Temperature	-40 – 60°C, >45°C Derating
Noise	< 30 dB @ 25°C (77°F)
Idle Consumption - No Load	60W
Communication and Monitoring	Wi-Fi & LAN Hardware Included
Warranty ³	10 Years (15 Years)
Category	
Certifications and Listings (Grid Support Interactive Inverter)	UL 1741-2021 (UL1741SB), CSA C22.2 No 107.1-16, IEEE 1547-2018 & 1547a-2020 & 1547.1-2020 (SRD V2.0), UL 1741 CRD-PCS, UL1699B, CEC, SGIP ⁴
PV DC Disconnect Switch – NEC 240.15	Integrated
Ground Fault Detection – NEC 690.5	Integrated
PV Rapid Shutdown Control – NEC 690.12	Integrated
PV Arc Fault Detection – NEC 690.11	Integrated
PV Input Lightning Protection	Integrated
PV String Input Reverse Polarity Protection	Integrated
Surge Protection	DC Type II / AC Type III

1. See Installation Guide for more details on sizing array strings. The highest input voltage is based on the open-circuit voltage of the array at the minimum design temperature.

2. Active BMS communication is required for all lithium batteries. A list of compatible batteries can be found on our website.

3. 5-year extension is available for purchase by registered Gold level installers only.

4. Pending listing.

1.3 Connection Requirements

1. AC / DC Connection Requirements

All wire runs should be sized to be at or below a 2.5% voltage drop at full load. Wire size must comply with your local electrical code.

Port	Terminal Rating	Terminal Wire Size Range (min-max)
GRID	200Aac	1/0 - 4/0 AWG
LOAD	200Aac	1/0 - 4/0 AWG
GEN	200Aac	1/0 - 4/0 AWG
MPPT	55Aisc	12 - 10 AWG
Battery Port A	50Adc	6 - 4 AWG
Battery Port B	50Adc	6 - 4 AWG

2. Sensors and Communications Requirements

Component	Wire Size Range	Max Distance
CT Sensor	16-23 AWG	0' - 10' [3 m]: 16 AWG included 10' - 20' [6 m]: CAT6 extendable
Communications	24 - 23 AWG	0' - 100' [30 m]: 24 AWG 100' - 400' [120 m]: 23 AWG
RJ45 Parallel Communication	CAT 5E or better	0' - 7' [2.1 m]: Included 7' - 20' [6m]: Extendable

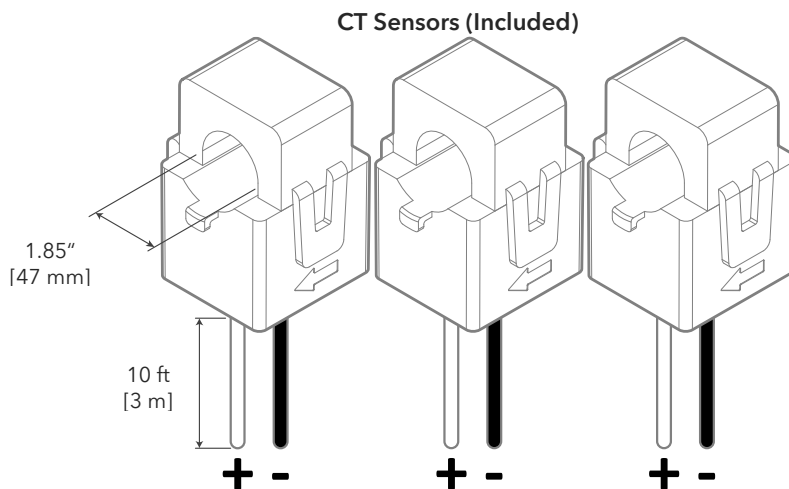
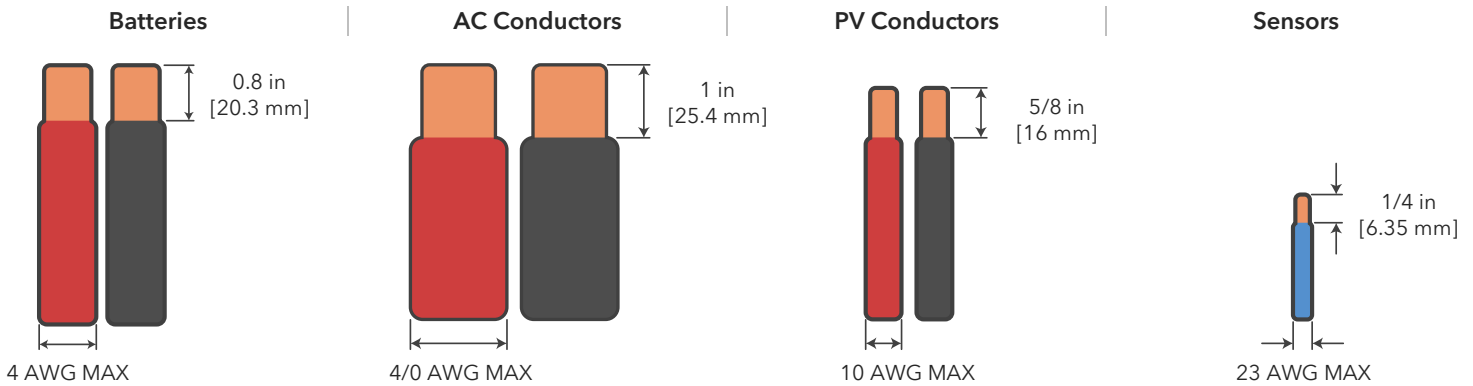

2. Installation

Backup Circuits

- A. The "LOAD" connected service panel will be referred to as the **Essential Loads Panel**.
- B. You must keep the essential loads panel within the limitations of the unit:
 - Three phase power in a Wye configuration is calculated as follows → Real Power (W) = $\sqrt{3} * V_L * I_L * PF$
Assuming a unity power factor (PF=1) then the following represents the maximum power levels for each condition.
 - Grid Tie → 149.6 kW = 1.73 * 480V * 180A continuous (passthrough).
 - Off-Grid → 60.1 kW = 1.73 * 480V * 72.3A continuous (batteries or PV).
- C. Verify that every load circuit power does not surpass the above limits.

Single System Install

- A. **FOR PARTIAL BACKUP:** Use a Line Side Tap as point of interconnection to integrate the utility grid to the Sol-Ark inverter through the "GRID" terminal.
 - An external disconnect must be installed between the interconnection and the Sol-Ark. Size the disconnect according to code.
 - Connect the "LOAD" output to the Essential Loads Panel. Follow electric code to select proper wire gauge.
- B. **FOR WHOLE-SITE BACKUP:** Connect the utility grid directly to the "GRID" terminal.
 - An external disconnect must be installed between the grid and the Sol-Ark. Size the disconnect according to code.
 - Connect the "LOAD" output to the Main Service Panel. Follow electric code to select proper wire gauge.

It is possible to connect a generator, or an AC coupled source such as grid-tie string or micro inverters to the "GEN" terminal of the inverter. Only one AC source can be connected to the "GEN" terminal at a time.

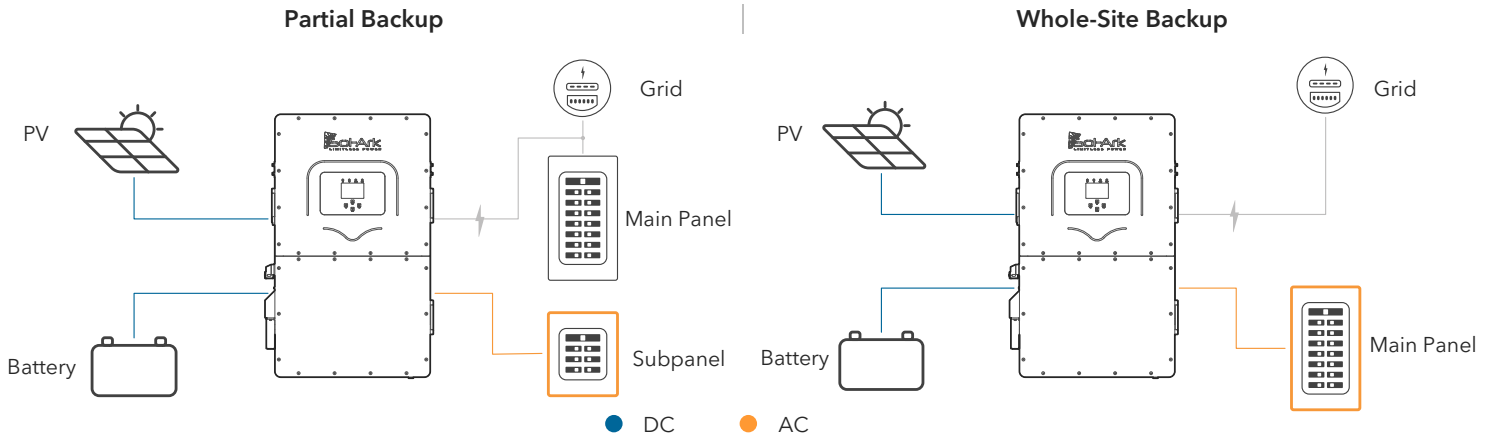

2.1 Mounting the Sol-Ark

- A. Considering the dimensions of the inverter, find a suitable location for the system. There must be at least 6 in [15 cm] of vertical clearance and 2 in [5 cm] of side clearance for proper heat dissipation.

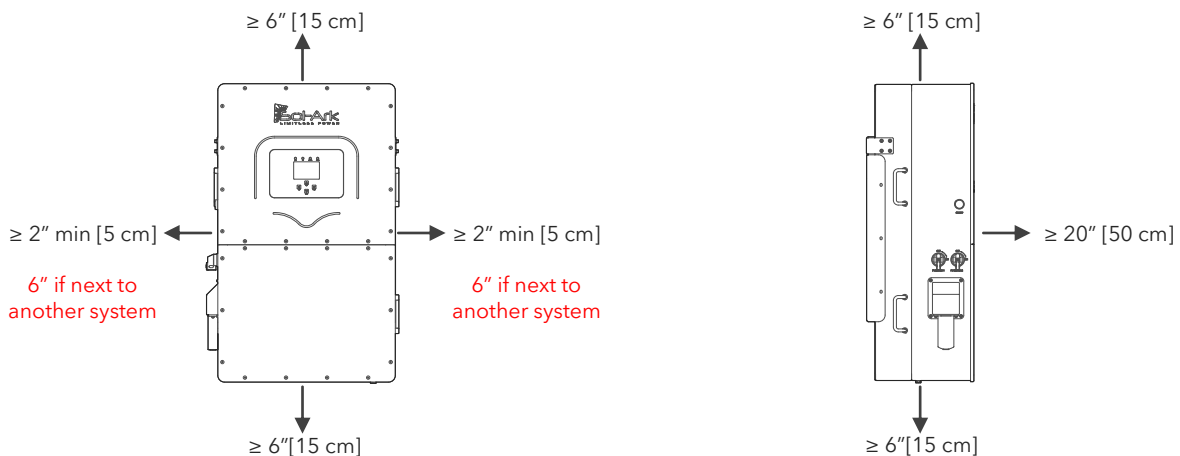

! Max heat dissipation of 2,100W MAX

- B. Under certain conditions, the National Electrical Code® specifies greater clearances. Ensure that the prescribed clearances in accordance with the National Electrical Code®, paragraph 110.26 and Canadian Electrical Code® CSA C22.1 are adhered to.
- C. The Sol-Ark 60K-3P-480V is a NEMA 3R - IP65 enclosure that is rated for outdoor installation but can also be installed indoors.
- D. **⚠️ PROTECT THE LCD SCREEN** from direct exposure to UV light.
- E. Use screws or anchors suitable for the support surface and capable of supporting the weight of the inverter (176 lb / 80kg).
 - a. For Concrete or Masonry Mounting: Use a minimum of four (4) M12x60mm expanding anchors (included).
 - b. For Wood Frame Mounting: Use a minimum of four (4) 1/2in lag screws with flat washers (not included), making sure to anchor into at least 2 framing members.
 - c. For Metal Framing Mounting: Use a minimum of four (4) 1/4in self-tapping metal screws with flat washers (not included).
 - d. In the case a different anchorage is required, calculate the number of anchor points needed to properly hold the weight of the equipment.
- F. Secure the inverter to the French Cleat with six (6) of the M4x12mm socket head screws provided.

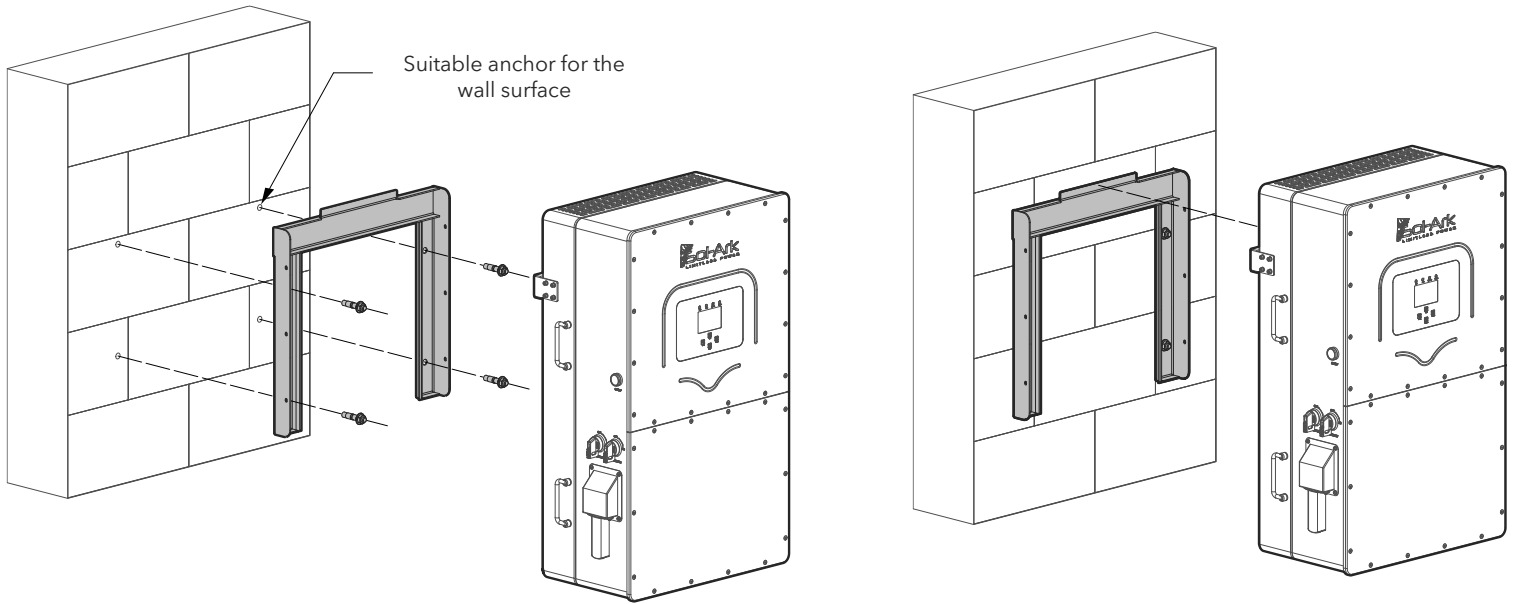

⚠️ *Damage to the LCD Screen due to direct sunlight exposure will not be covered by warranty*

- G. Mount the inverter in the optimal orientation as shown below.

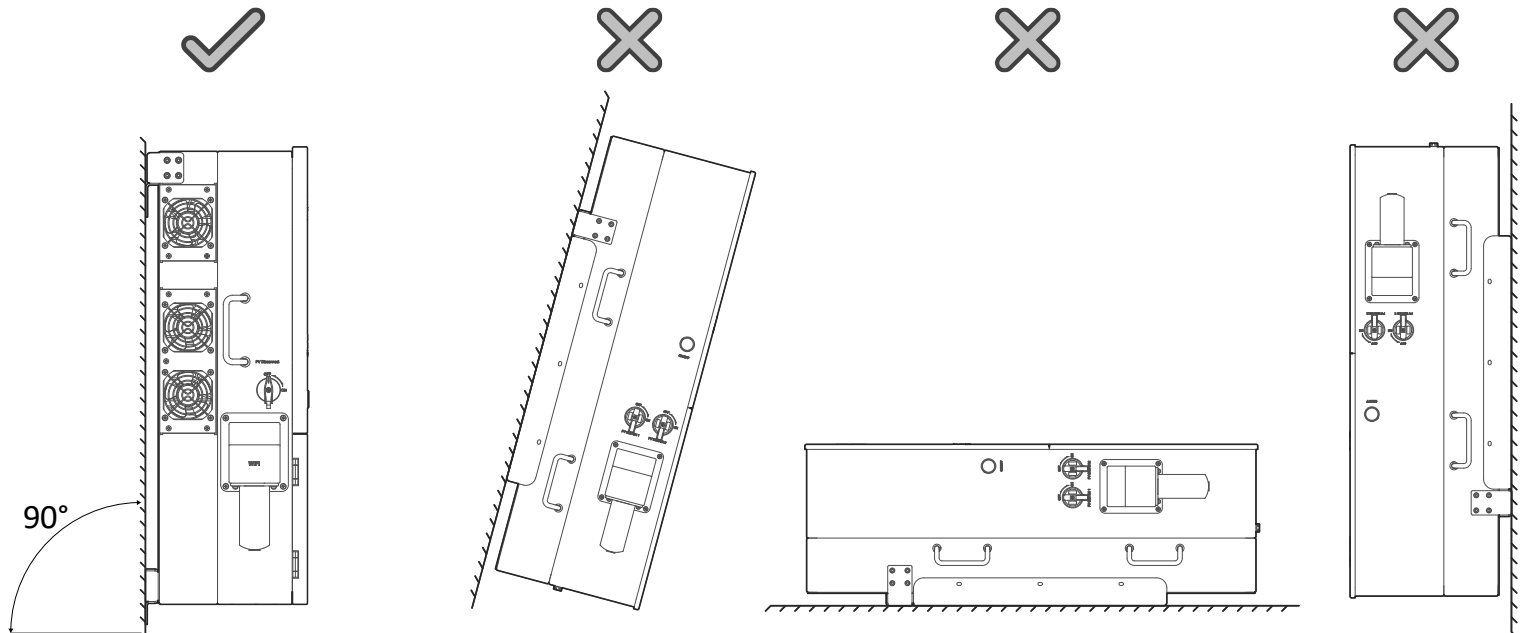

2.2 Integrating Batteries

- A. ⚠ Sol-Ark 60K-3P-480V must be OFF while the batteries are being connected.
- B. Ensure the external battery disconnect is OFF or arcing may occur. If your battery bank does not have built-in breakers, maintain the necessary safety measures when handling the connections.
- C. ⓘ The 60K-3P-480V reaches a max battery charge/discharge of 50A per terminal for a total max of 100A if using both sets of battery terminals. If only one set of terminals is used, the battery charge/discharge will be limited to 50A.

⚠ Sol-Ark 60K-3P-480V is a **HIGH VOLTAGE BATTERY** system. You **MUST NOT** exceed **800V_{DC}** as shown below. The HV battery must stay within the **160V_{DC} - 800V_{DC}** voltage range. **DO NOT** connect to any other nominal voltage that exceeds this limit.

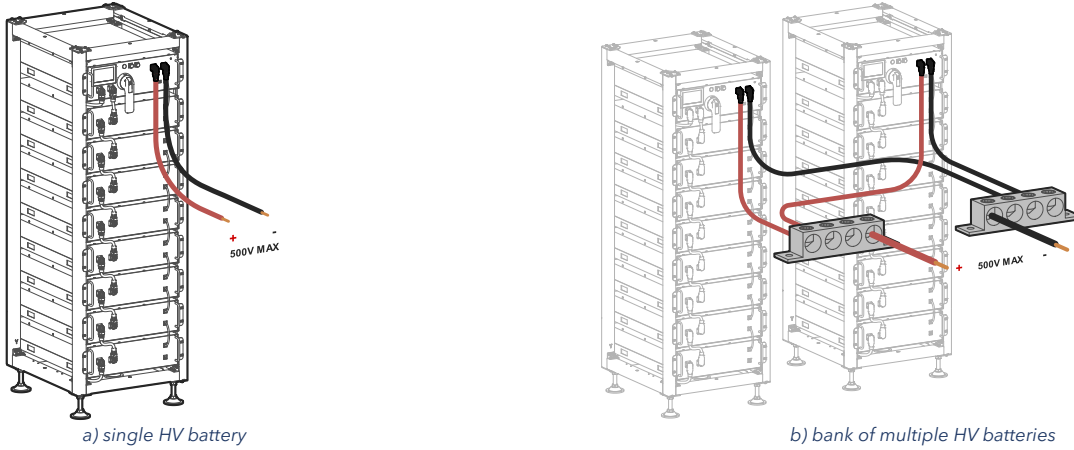

The Sol-Ark inverter has two input battery terminals for single or dual battery connections. To wire a battery to the inverter, pull the actuation levers and insert the 6-4 AWG battery conductor. **DO NOT** force open the battery actuation levers more than 45°.

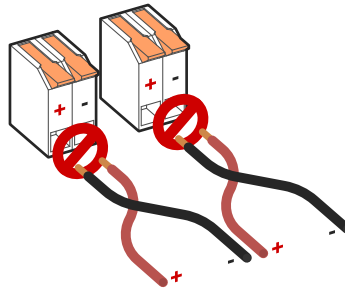

⚠ DO NOT reverse polarity. The system will be damaged, and warranty will be voided!

1. Multi-Terminal Installation

The two battery input terminals of the 60K-3P-480V will parallel batteries internally to ensure a common connection between battery banks and simplify battery installations. If a charge / discharge rate of 100A is needed, the batteries must be connected to both input terminals. If using 3 or more batteries, use external busbars for (+) and (-) connections.

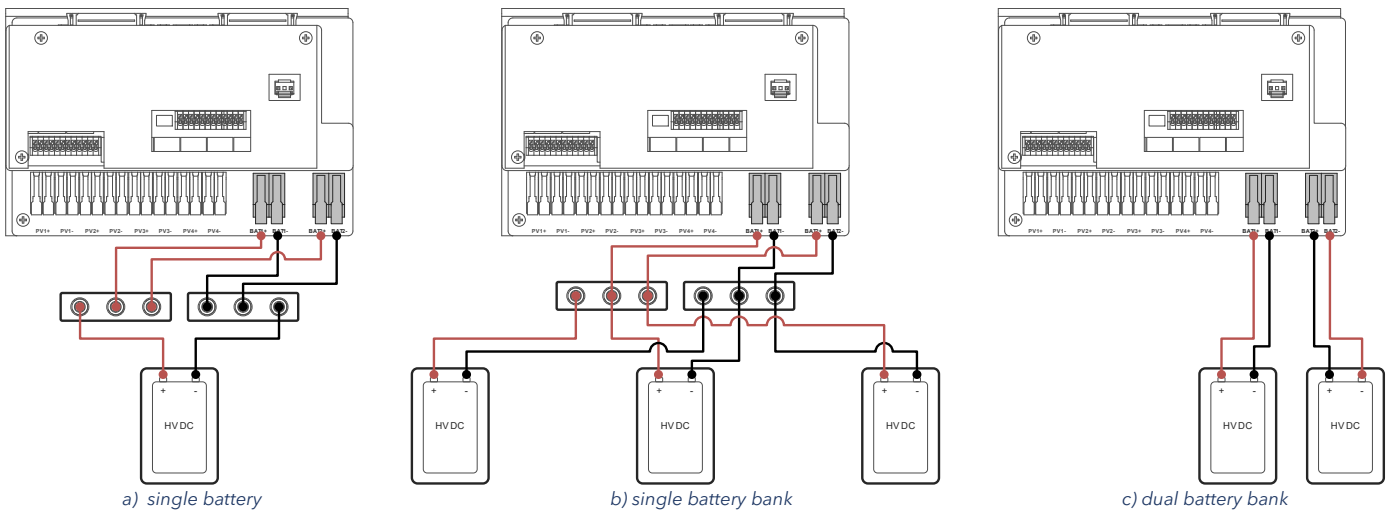

! If a single battery is capable of charging / discharging above 50A, connect the battery to both input terminals. Otherwise, the charge and discharge rate will be limited to 50A max. Connect batteries of the same brand, model, and chemistry to the terminals

2. Multi-System Installs

⚠ Please contact Sol-Ark technical support at support@sol-ark.com or (972) 575-8875 Ext. 2 before performing a multi-system installation.

- A. **ALL** systems **MUST** be connected to their own HV battery / battery bank.
- B. **DO NOT** parallel batteries between inverters.

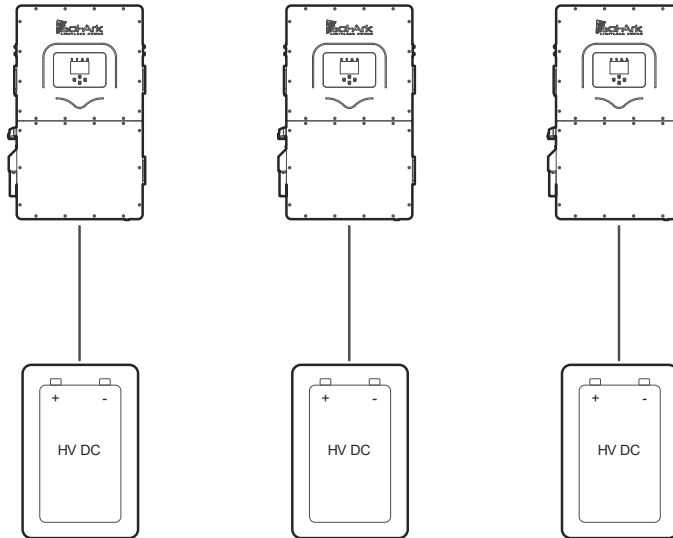

2.3 Battery Communications

The Sol-Ark inverter can establish closed-loop battery communication through the RJ-45 port labeled "BMS1". Configure and wire the HV batteries so that there is one battery bank with a single communication source. Closed-loop communication is established by connecting the communication cable to the "BMS1" port of the Sol-Ark inverter.

! "☑ Parallel Bat1&Bat2" setting on the Batt setup menu **MUST** be enabled and multi-terminal wiring **MUST** be carried out. See previous section "Multi-Terminal Installation" for detailed wiring of multi-terminal, single battery bank installation.

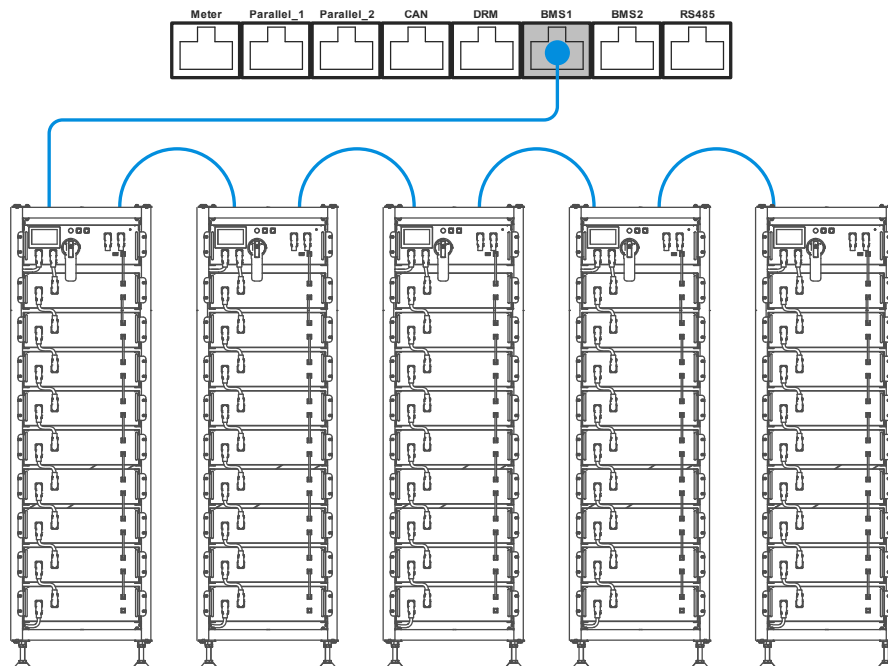

Single battery bank communication

2.4 Connecting PV Modules

! The Sol-Ark 60K-3P-480V has 4 independent MPPTs that support up to 2 PV strings each. MPPTs can handle a maximum V_{oc} of 1,000V and an I_{sc} of 55A but will self-limit and operate at I_{mp} of 36A max.

- A. Max DC solar input = 78 kW ($\pm 5\%$) | Max input power per MPPT = 19.5 kW | Max recommended input voltage per MPPT = 850 V_{oc} | Max input current per MPPT = 36A (self-limiting).
- B. ⚠️ Design for an input current of 36A per MPPT. The inverter will self-limit beyond 36A. If I_{sc} exceeds 55A, damage will occur.
- C. ⚠️ **PV Source Circuit max voltage of 1,000V $_{oc}$; damage can occur with PV strings whose open-circuit voltage exceeds 1,000V $_{oc}$**
- D. ! Strings in parallel on the same MPPT must have the same designed open-circuit voltage (V_{oc}), otherwise the system will be limited to the lowest string voltage.
 - i. PV1 A/B must have the same V_{oc} .
 - ii. If the solar panels are oriented in different directions and connected in the same MPPT, there will be a loss in PV efficiency.
- E. ! Per NEC Art 690.43, exposed non-current-carrying metal parts of PV module frames, electrical equipment, and conductor enclosures of PV systems shall be connected to an equipment grounding conductor. All grounding conductors and grounding electrodes should be installed according to NEC Art 690.47 or as required by the AHJ.
- F. For ground mounted arrays, Sol-Ark recommends installing an auxiliary grounding electrode placed near the array to ensure optimal earth-to-ground resistance of the grounding system. This auxiliary electrode would need to follow the requirements of NEC Art 250.54.
- G. Connect the solar panel strings using either of the following configurations:

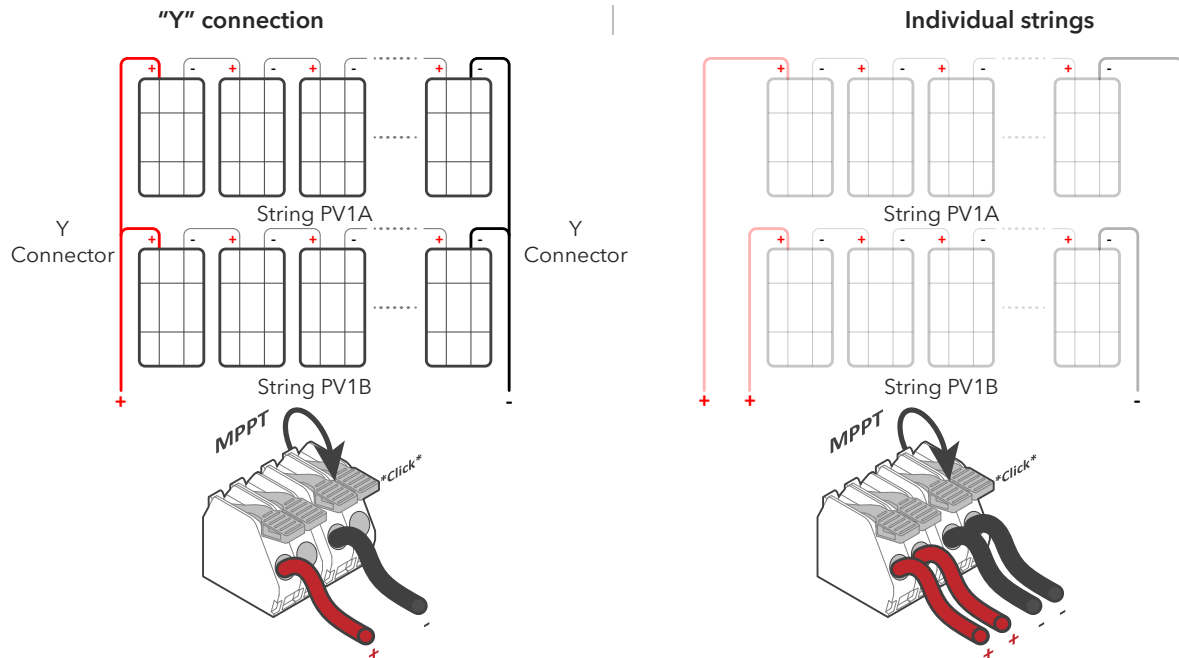

AC Coupling

The Sol-Ark 60K-3P-480V is a system that supports the addition of AC coupled solar panels. The max solar input power can be expanded by coupling 3 Φ micro or string inverters into the "GEN" terminals. A full AC coupled solar system is not recommended as power control and monitoring is limited. Having DC coupled modules or a combination of DC coupled and AC coupled solar panels is always preferred.

3 Φ AC coupled inverters need to be either UL 1741SA or UL 1741SB certified. This certification confirms the inverters' ability to disconnect from the grid based on frequency and ensures that the Sol-Ark will safely be able to frequency shift to control the AC coupled production.

! Batteries are **REQUIRED** to AC couple solar panels to the "GEN" terminal. The AC coupled inverters can still produce solar power even during grid outage events or in Off-Grid systems. Furthermore, the total AC coupling production will be monitored.

Maximum allowed AC coupling input: 60,000W $_{AC}$

! In Off-Grid systems, Sol-Ark uses **Frequency Shift** technology to shut down AC coupled solutions when the battery is full. Grid-Tied AC coupled solutions will **always** sell excess solar power back to the grid. "Limited to Load" will **NOT** limit production when AC coupled.

2.5 Integrating a Generator

Generators Smaller than 149.6kW → On "GEN" Input

1. **ONLY** supports three-phase 208V generators.
2. 200A rated "GEN" terminal. **!** 180A continuous.
3. A THD (Total Harmonic Distortion) of less than 15% is preferred.

Generators Greater than 149.6kW → On "GRID" Input

1. **ONLY** supports three-phase 480V generators.
2. Optimal way to integrate generators for Off-Grid or Grid-Tied systems with automatic or manual transfer switches.
3. **!** Programming "GEN Connect to Grid Input" is required: ⚙️ → *Limiters* → *Other* → **GEN Connect to Grid Input**
4. **⚠️ DO NOT** use "Grid Sell" in Off-Grid systems. Potential to damage the generator. Installation of CT sensors on generator lines is only required if "Peak Shaving" is intended to be used.

Improve the Generator & Sol-Ark Compatibility

Navigate through the menus and program the following settings to improve the Sol-Ark and generator compatibility and operating range to avoid frequent disconnections.

1. Change the grid mode to General Standard: ⚙️ → *Grid Setup* → *Grid Selection* → *Grid Mode*.
 - a. Tap and use the navigation arrows to cycle through the different grid modes. Choose "**General Standard**".
2. Increase the frequency range of operation: ⚙️ → *Grid Setup* → *Connect* → *Reconnect*
 - a. Increase "**Grid Hz High**" to **65Hz**.
 - b. Decrease "**Grid Hz Low**" to **55Hz**.
 - c. Replicate changes for the "Normal Connect" settings.
3. Increase the voltage range of operation:
 - a. Increase "**Grid Volt High**" to **528V**.
 - b. Decrease "**Grid Volt Low**" to **432V**.
 - c. Replicate changes for the "Normal Connect" settings.

2.6 Grid Peak Shaving

1. **!** To use Peak-Shaving on a generator, the equipment **MUST** be connected to the "GRID" terminal of the inverter.
2. Peak-Shaving helps reduce grid consumption during peak demand by utilizing battery backup power. It can also be used to prevent generator overload above a specified power threshold.
3. Install the CT sensors on grid / generator lines L1, L2, L3. The arrows on the CTs **MUST** point toward the inverter.
4. The Sol-Ark supplies power from the batteries whenever the "**Power**" threshold is met.
5. This mode will automatically adjust the "Grid Charge" amperage (**A**) to avoid generator overloads during battery charging.
6. **!** Grid Peak-Shaving will automatically enable "Time of Use" and **MUST** be configured.

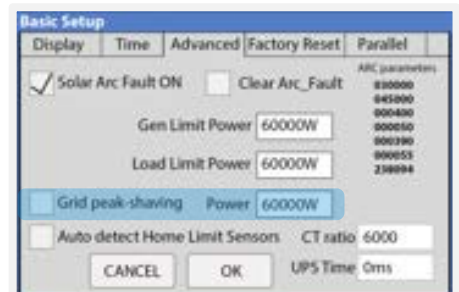



Grid peak-shaving settings

2.7 Automatic Generator Start

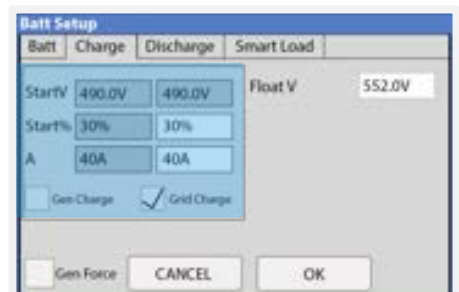
1. **Gen Charge** is used when the generator is connected to the "GEN" terminal.
 - a. "**Start V**" or "**Start %**" is the set-point/condition that must be fulfilled to automatically start the generator.
 - b. To charge from the "GEN" source, " Gen Charge" must be enabled.
 - c. **!** Batteries will charge from a generator until the battery bank accepts 5% of its programmed capacity in Amperes (A). This is equivalent to around 95% of the state of charge (SOC).



Generator and grid charge settings

2. **Grid Charge** is used to charge the battery from the **"GRID"** source (grid or a generator).
 - a. **"Start V" or "Start %"** is the set-point/condition that must be fulfilled to start the battery charge from the "GRID" source. This will auto-start a generator as well.
 - b. To charge the battery from the "GRID" source, Grid Charge must be selected: ⚙️ → Battery Setup → Charge.
 - c.  From utility grid: the batteries will be charged to 100% SOC.
 - d.  From generator: the batteries will charge until the battery bank accepts 5% of its rated capacity in Amperes (A). This is equivalent to around 95% SOC.

 If **"Time of Use" (TOU)** is enabled, a time to charge from that GRID or GEN source **MUST** be designated. **Charge** must be checked on desired time intervals, otherwise the generator will not start automatically even if the Start V or Start % condition has been met.

Gen Charge / Grid Charge "A"

"A" is how many amps (DC) are supplied to the battery from the "GRID" or "GEN" source. Adjusting and limiting the Gen or Grid "A" value will ensure that small generators are not overloaded when charging the battery bank.

If connecting more than one HV battery in parallel to the Sol-Ark inverter, divide the Gen or Grid "A" value by the **# of batteries** to estimate the current (A) flowing to each HV battery.

2.8 Integrating Sensors and Accessories

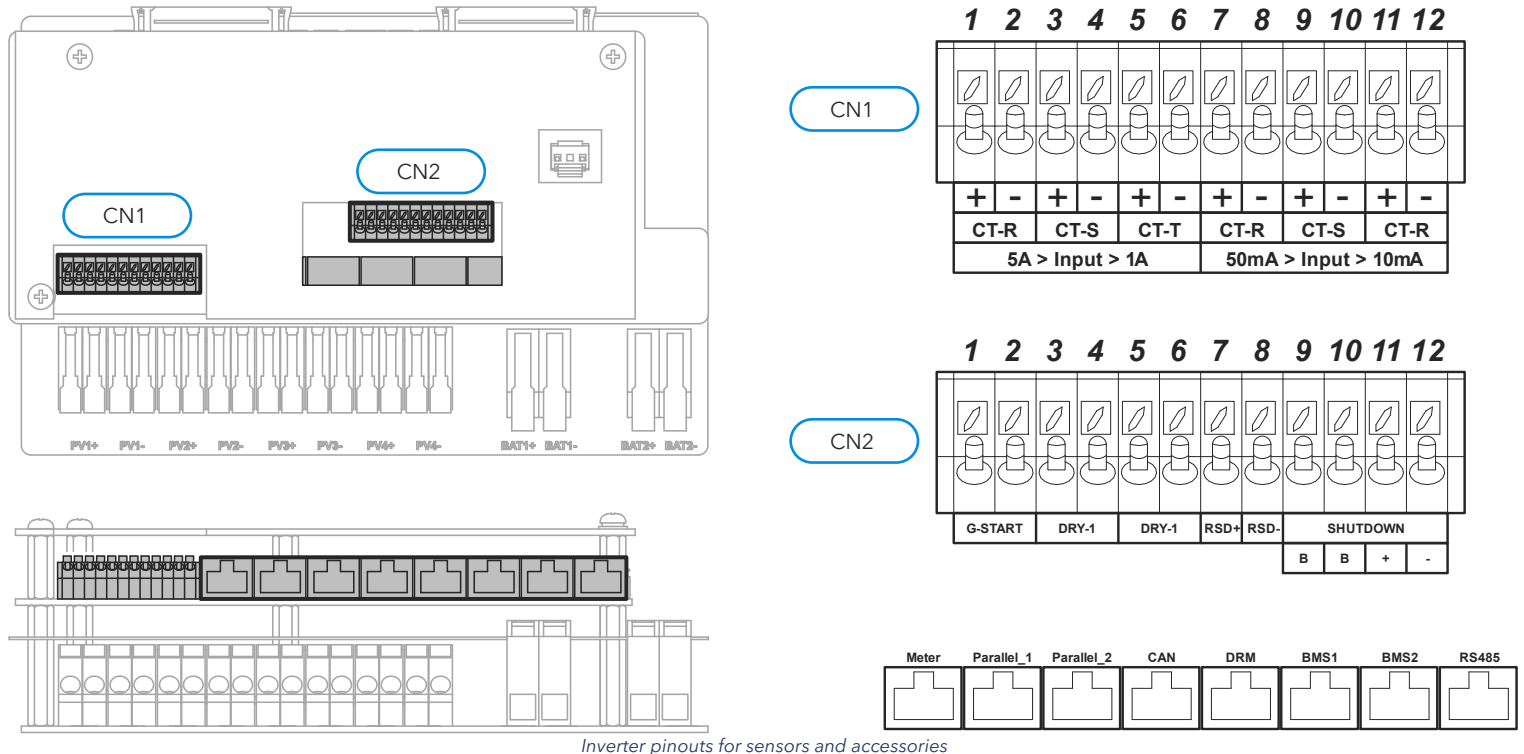

1. Sensor Pin Out (Located in Sol-Ark user area)

CN1:

- (1,2,7,8) **CT-R**: Current transformer (L1). **Polarity sensitive.**
- (3,4,9,10) **CT-S**: Current transformer (L2). **Polarity sensitive.**
- (5,6,11,12) **CT-T**: Current transformer. (L3). **Polarity sensitive.**

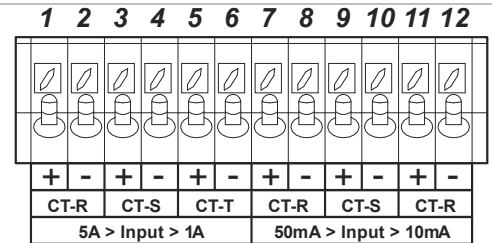

CN2:

- (1,2) **G-Start**: Normally open relay for generator two-wire start (⚠️ 12V, 100mA max)
- (3,4) **Dry-1** and (5,6) **Dry-2**: Reserved
- (7,8) **Optional RSD**: 12Vdc (-3%) power supply for RSD transmitters (100mA max, 12Vdc, 1.2W)
- (9,10) **Emergency stop**: Normally open dry contact for emergency stop button
- (11, 12) +/- : are not used at this time.

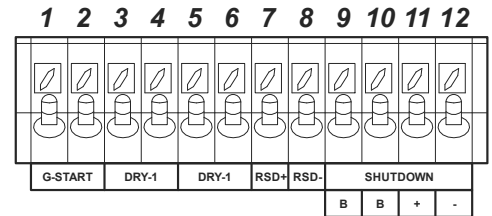

2. Communication Ports

- **Meter**: For external energy meter communication.
- **Parallel_1 & Parallel_2**: Parallel communications ports 1 and 2.
- **CAN**: Reserved.
- **DRM**: Reserved.
- **RS-485**: RS-485 port
- **BMS1 & BMS2**: BMS ports 1 and 2 for battery communications

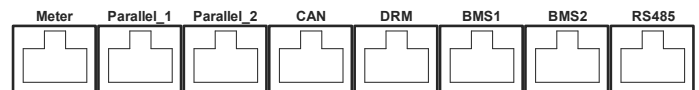

3. CAN Bus & RS485 Ports

- CAN port data is in a proprietary format. Sol-Ark does not support 3rd party usage currently.
- The RS485/RTU port utilizes the MODBUS protocol, data is in a proprietary format. Please contact Sol-Ark to request an NDA if the MODBUS mapping is required for your application.

Pin	RS485	CAN
1	B-	B-
2	A+	A+
3	--	--
4	--	CAN Hi
5	--	CAN Lo
6	GND	GND
7	A+	A+
8	B-	B-

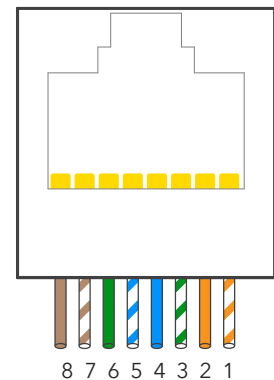

4. GEN Start Signal (Two-wire start)

- Gen start relay: CN2, pins 1 & 2.
- The signal comes from a normally open relay that closes when the generator **"Start"** condition is met.

5. Wi-Fi / Ethernet Antenna (Dongle)

- Remote monitoring and software updates require an internet connection through the Wi-Fi / Ethernet Antenna (Dongle).
- Compatible with Wi-Fi or Ethernet connections.

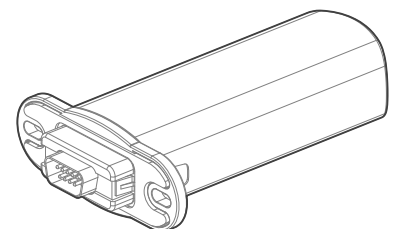

2.9 Limit Sensors (CT sensors)

The CT sensors (or limit sensors) enhance system capabilities by enabling the use of the system work modes known as **"Limited Power to Home"** (Meter Zero) and **"Grid Peak-Shaving"**. The CTs will measure and calculate total load demand which the Sol-Ark 60K-3P-480V will then use to accurately supply and offset all existing loads (Meter Zero).

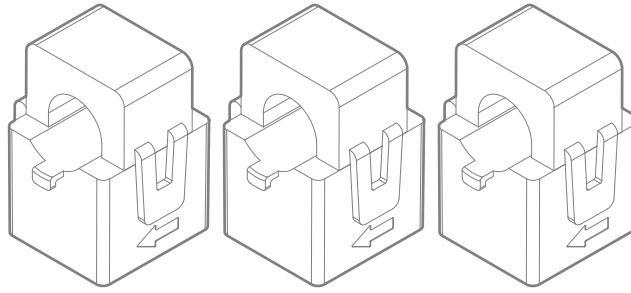

! Off-Grid system do not require CT sensors unless "Grid Peak-Shaving" is used

1. CT Sensors Installation

- Install sensors on incoming electrical service wires (L1, L2, L3).
- Embossed arrows on the CT sensors must point towards the inverter.
- To ensure proper fit, check incoming wire diameters (grid or generator). If the sensors are too small, larger CTs can be purchased by contacting sales: +1-972-575-8875 ext. 1 or sales@sol-ark.com
- **"Limited Power to Home"** (Meter Zero) and **"Grid Peak Shaving"** require CT sensors.
- See section 3.5 "Limiter" for more information about the different work modes.
- See section 7 "Wiring diagrams" for more information on CT installation.

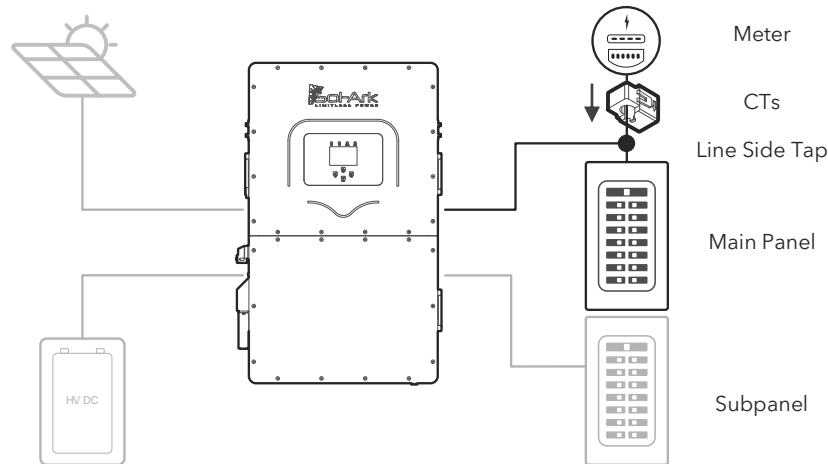

2. CT Sensor Size

- The Sol-Ark 60K-3P-480V includes three **300A** CT sensors (Ø2").
- Sol-Ark offers large **200A** (Ø0.945") and extra-large **600A** (Ø1.976") CT sensors upon request. Visit <https://shop.sol-ark.com/> or contact sales at +1 (972) 575-8875 / sales@sol-ark.com to purchase bigger CT sensors.
- Default Sol-Ark CT ratio is 6000:1

! Unless authorized, **DO NOT** change CT Ratio or warranty will be voided

3. Wiring the CT sensor

- Connect CT1 of line L1 to pins 1 (white) & 2 (black) of CN1 pin board.
- Connect CT2 of line L2 to pins 3 (white) & 4 (black) of CN1 pin board.
- Connect CT3 of line L3 to pins 5 (white) & 6 (black) of CN1 pin board.
- Keep the wires twisted (white-black) throughout the connection.
- If the wires need to be extended, use CAT 6 (shielded) cable to make an extension.

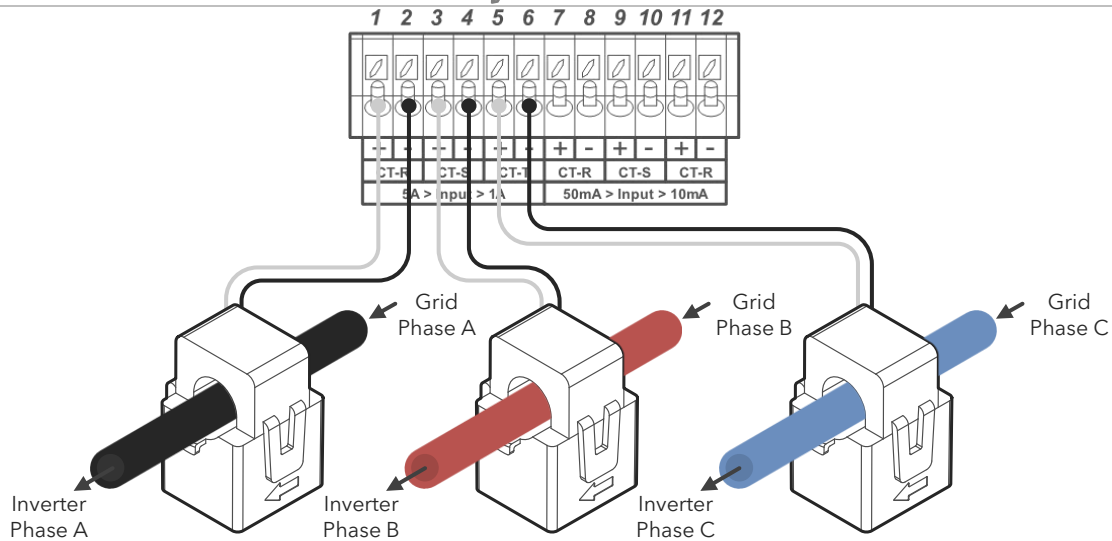

CT Sensors for multi-system installs

- ⚠ Contact Sol-Ark technical support at support@sol-ark.com or (972) 575-8875 Ext. 2 before performing a multi-system installation.
- Each inverter will include three (3) CT sensors.
- Only one set of CT sensors need to be wired to the designated "Master" inverter.
- 📢 CT sensors are essential for multi-inverter systems as "Limited Power to Home" mode is highly recommended.

CT wire extensions with shielded CAT 6 cable

4. Automatic CT Limit Sensors Configuration

This function **REQUIRES** batteries to auto detect and auto correct CT orientation. AC coupled inverters need to be **OFF** during the detection test. If this test is done with connected AC-coupled systems, a factory reset of the Sol-Ark must be performed. Install the CT sensor as described previously. A battery connection and grid power are required before starting the automatic configuration.

⚙️ → Basic Setup → Advanced → Auto detect Home Limit Sensors



Wait at least 10 to 15 seconds while the inverter performs the test. The inverter will alternate the current distribution in all lines, determining the correct orientation of the sensor.



- On "Limited power to Home" mode (no Grid Sell), HM values will read close to zero (0). Keep in mind that all sensors have a 3% error.
- To avoid selling power to the utility use "Zero Export Power" equal to or greater than 20W.
- Buying power from the grid will display positive (+) HM values, while selling to the grid displays negative (-) HM values.

2.10 Emergency Stop and Rapid Shutdown

The (B, B) emergency stop pins of the Sol-Ark 60K-3P-480V are an ordinarily open contact that triggers rapid shutdown (RSD) when closed. RSD will cut all power including the Sol-Ark's internal power supply and stop all AC outputs. The internal 12Vdc (-3%) power supply of the Sol-Ark (CN2, pins 7 & 8) will disconnect any RSD transmitter that will then shut down all solar panels when the emergency stop button is pressed.

- Emergency stop button connects to CN2, (B, B) pins 9 & 10 of the Sol-Ark.
- RSD transmitter connects to CN2, pins 7 & 8 (12Vdc power supply)
-  Transmitters placed inside the user area of the Sol-Ark can cause interference.
-  On multi-system installations, the emergency stop button must be wired to the designated "Master" inverter.

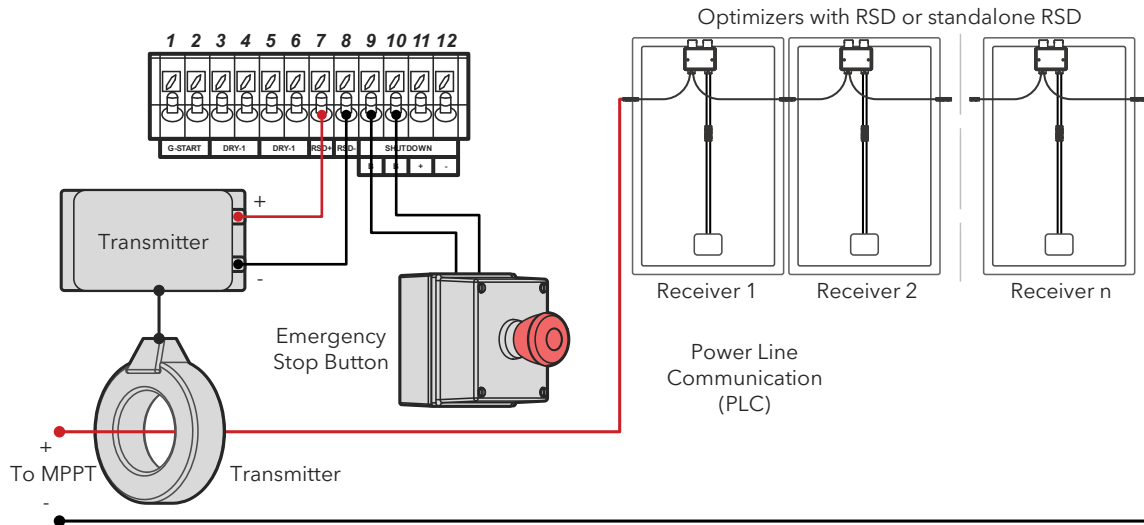

RSD Warning!
 The Built-in 12Vdc power supply of the Sol-Ark 60K-3P-480V (Pins 7 & 8) is rated for **100mA (1.2W)**. Do not exceed! If unsure of the current (A) rating of the transmitter, contact the manufacturer before connecting

A transmitter that exceeds the maximum 100mA limit can still be integrated into the Sol-Ark inverter through an external power supply connected to the "LOAD" output. Pressing the e-stop button will disconnect all AC outputs, cutting power to the "LOAD" connected service panel which will initiate rapid shutdown.

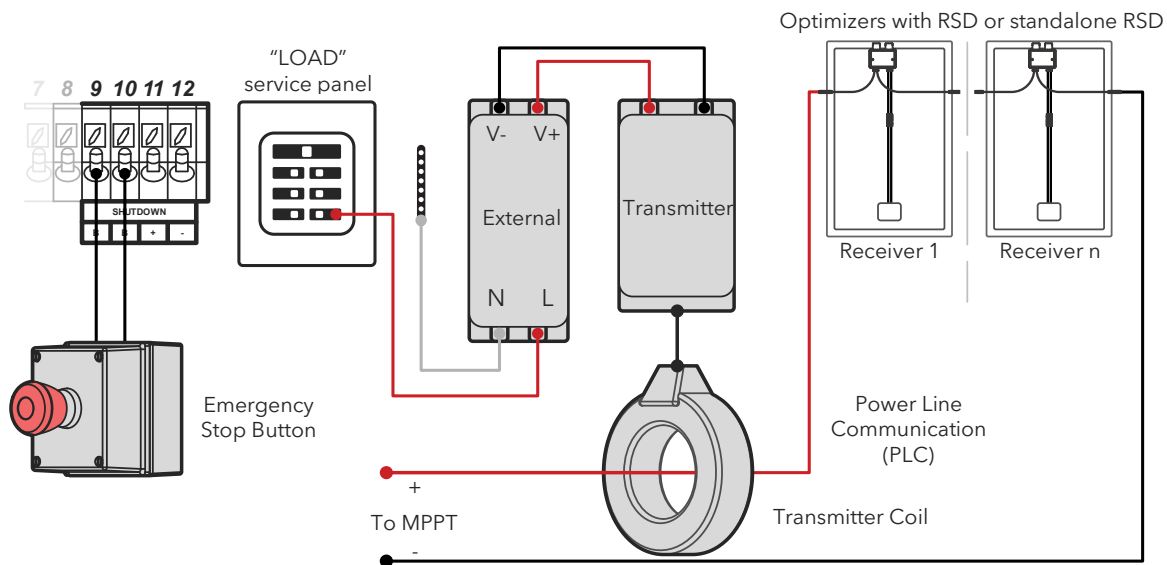

Rapid Shutdown Recommendations

TIGO TS4-A-O

TIGO TS4-A-F

TIGO TS4-O

TIGO TS4-O-DUO

APsmart RSD S-PLC / RSD-D

2.11 Powering-up and Testing the Sol-Ark

! TURN ON the inverter with at least one power source: 1) Battery, 2) PV or 3) Grid

1. Check the voltage of the battery bank

- ⚠ Voltage of the battery must be between $160V_{DC}$ - $800V_{DC}$.
- Turn **ON** battery modules and ensure appropriate voltage on each battery. Verify nominal voltage of battery bank.
- Turn **ON** the external battery disconnect. Verify that the voltage at the Sol-Ark terminals is adequate.
- ⚠ **DO NOT** reverse polarity. **DO NOT** turn **OFF** battery disconnect if any current is flowing in or out of the battery.

2. Check the voltage of each PV input circuit

- ⚠ Input voltage must not exceed $1,000V_{DC}$.
- Input voltage must be above the startup voltage of $150V_{DC}$.
- ⚠ Do not ground PV+ or PV-.
- ⚠ Verify polarity in each PV string. Backward polarity will measure $0V_{DC}$ by the Sol-Ark and will cause long term damage.
- ! PV alone turns LCD screen only. Inverter requires **grid** and/or **batteries** to operate, otherwise an "OFF" message will appear.
- PV DC disconnect switches on the side of the inverter turn the PV ON or OFF.

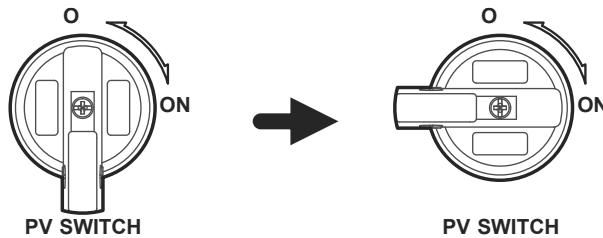

3. Check GRID input voltage

- Use the "GRID" terminals to measure AC voltage with a multimeter.
- Measure line (L) to neutral (N) voltages on "GRID" terminals. Ensure $277V_{AC}$ on all phases.
- Measure line (L) to line (L) voltages on "GRID" terminals. Ensure $480V_{AC}$.
- Verify that voltage between Neutral and Ground is $0V_{AC}$.
- Verify that voltage between "GRID" L1 and "LOAD" L1 is $0V$. Do the same for L2 and L3.

4. Power ON Sol-Ark 60K-3P-480V

- Turn **ON** the external "GRID" disconnect. Wait for the "AC" LED indicator to turn on.
- Turn **ON** the PV DC disconnect switches. Wait for the "DC" LED indicator to turn on.
- PRESS** down the power button to the **ON** position. Wait for the "Normal" LED indicator to turn on. This may take a few minutes.
- Turn **ON** the external battery breaker if the system has batteries.
- Turn **ON** the external "LOAD" and "GEN" breakers.

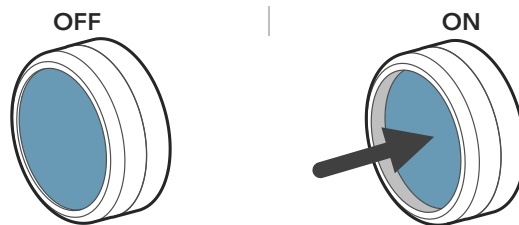

2.12 Power Cycle Sequence

- TURN OFF** the external battery breaker if the system has batteries.
- PRESS** the power button, making sure it is in the **OFF** position. An "OFF" message will appear after the "Normal" LED turns off.
- TURN OFF** the built-in PV DC disconnect switches on the side of the inverter.
- TURN OFF** all AC breakers / disconnects ("GRID", "GEN" and "LOAD").
- Wait a moment (~1 min) to ensure the inverter is completely de-energized.
- Make sure that the Sol-Ark is properly connected to the batteries, solar panels, "GRID", "GEN", and "LOAD".
- Reverse the steps to turn **ON** the Sol-Ark.

3. User Interface

3.1 LED Indicators

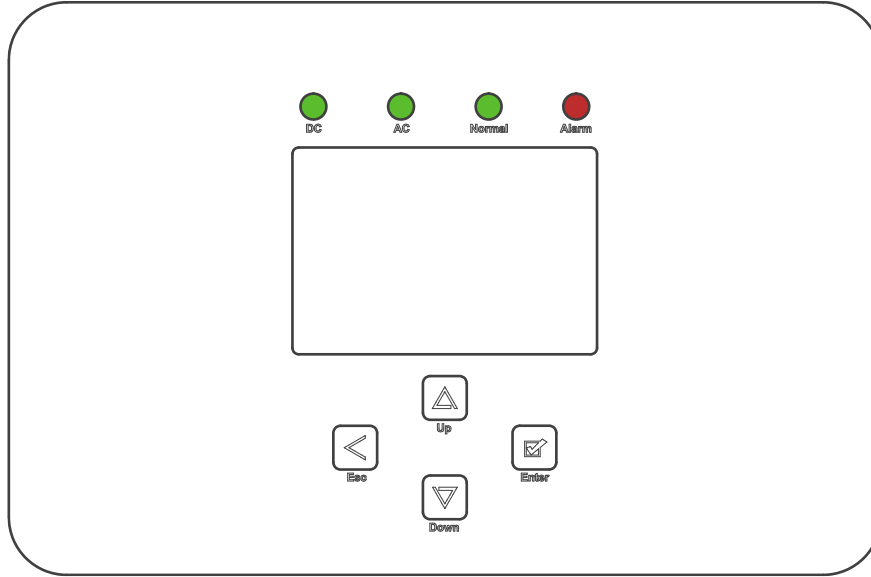

DC	AC	Normal	Alarm
Green → DC Solar Panels connected and providing voltage.	Green → Grid is connected and providing voltage.	Green → Sol-Ark is fully energized* and operating.	Red → Alarm state. Check the alarms menu. Home Screen → ⚙️ → "System Alarms"
OFF → Minimum MPPT voltage not met, wrong polarity or no PV _{DC} .	OFF → Grid voltage out of range or Off-Grid system.	OFF → Not fully energized*, in fault state or in passthrough mode.	OFF → No alarms / error codes / setting change notifications

! **Fully energizing the unit constitutes at least: a) DC Solar panels AND Grid or b) Just batteries*

3.2 Main Menu

The screenshot displays the main menu with the following sections:

- System Status:** Solar Today=0.0 KWH, Total=0.0 KWH, 100% battery level.
- Energy Gauges:** Four circular gauges for Solar (60.00 KW), Grid (0.00 KW), Inverter (0.00 KW), and Battery (0.00 KW).
- System Alarms:** 1/25/2021 03:05:27 PM Mon. Alarms Code: F13 Grid_Mode_changed Occurred: 2021-01-13 11:22.
- System Data Table:**

Solar	Grid	INV	USP LD	Batt
0V	0V	60.0Hz	0V	0V
0V/0.5A	0.0Hz		L1: 0V	0.0V/ 0%
M1: 0W	L1: 0V	L1: 0V	L2: 0V	0.00A
364V/0.0A	L2: 0V	L2: 0V	L3: 0V	0.0C
M2: 0W	L3: 0V	L3: 0V	L1: 0W	0.00V/ 0%
0V/0.1A	HM1: 0W	L1: 0A	L2: 0W	0.00A
M3: 0W	HM2: 0W	L2: 0A	L3: 0W	0.0C
362V/0.8A	HM3: 0W	L3: 0A	Gen 60.0Hz 0W	
M4: 0W	LD1: 0W	L1: 0W	L1: 0V	L1: 0W
	LD2: 0W	L2: 0W	L2: 0V	L2: 0W
	LD3: 0W	L3: 0W	L3: 0V	L3: 0W
TEMP				
AC:19.4C				
- System Setup:** 10/14/2022 03:05:27 PM Fri. Options include Basic Setup, System Alarms, Battery Setup, Li-Batt info, Limiter, and Grid Setup.
- System Info:** Sol-Ark 60K-3P-HV, ID: #, COMM: #, MCU: Ver###.
- Battery Data Table (Only w/ BMS Lithium Mode):**

V	A	C	%	V	A	%
1. 60.0V	0.00A	0.0C	0.0%	6.0V	0.0A	0.0%
2. 60.0V	0.00A	0.0C	0.0%	6.0V	0.0A	0.0%
3. 60.0V	0.00A	0.0C	0.0%	6.0V	0.0A	0.0%
4. 60.0V	0.00A	0.0C	0.0%	6.0V	0.0A	0.0%
5. 60.0V	0.00A	0.0C	0.0%	6.0V	0.0A	0.0%
6. 60.0V	0.00A	0.0C	0.0%	6.0V	0.0A	0.0%
7. 60.0V	0.00A	0.0C	0.0%	6.0V	0.0A	0.0%
8. 60.0V	0.00A	0.0C	0.0%	6.0V	0.0A	0.0%
9. 60.0V	0.00A	0.0C	0.0%	6.0V	0.0A	0.0%
10. 60.0V	0.00A	0.0C	0.0%	6.0V	0.0A	0.0%
11. 60.0V	0.00A	0.0C	0.0%	6.0V	0.0A	0.0%
12. 60.0V	0.00A	0.0C	0.0%	6.0V	0.0A	0.0%
13. 60.0V	0.00A	0.0C	0.0%	6.0V	0.0A	0.0%

1. Main Screen

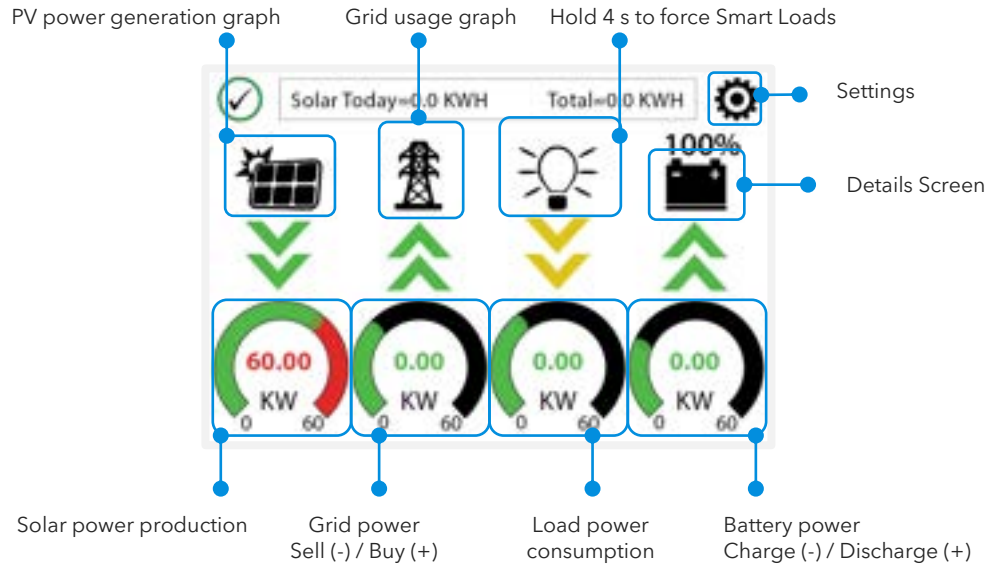

2. Details Screen

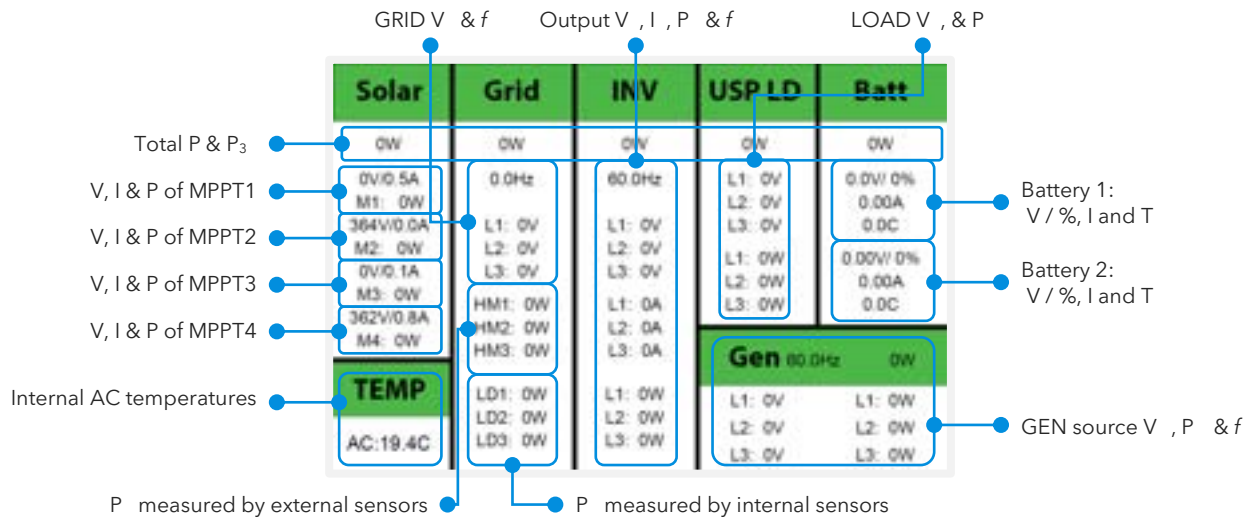

- MPPT voltages **MUST NOT** exceed 1,000V.
- "TEMP" measures the internal temperatures of the AC conversion power electronics.
- "Grid" column measures: Voltage, Current, Power and frequency of the utility grid.
 - If selling to the Grid: Watts = negative (-)
 - If buying from the Grid: Watts = positive (+)
 - HM: power measured by the external CT sensors. (L1, L2 & L3).
 - LD: power measured by the internal sensor on "GRID" terminal. (L1, L2 & L3).

Opposing "Grid" or "HM" values indicate an incorrect installation of CT. See section 2.9 "Limit Sensor"

3. PV power Generation Graph

- Tap the solar panel icon to display the PV power generation graph.
- Displays power production over time for the PV array.
- Use up/down arrows (,) to navigate between days.
- Month view/ year view/ total production.

4. Grid Usage Graph

- A. Tap the grid icon to display the grid usage graph.
- B. Displays power drawn from grid (+) / sold to the grid (-).
- C. Values above the line indicate "power bought" from the grid.
- D. Values below the line indicate "power sold back" to the grid.
- E. This view can help to determine when the peak power is used from the grid.

5. System Setup Menu



3.3 Basic Setup

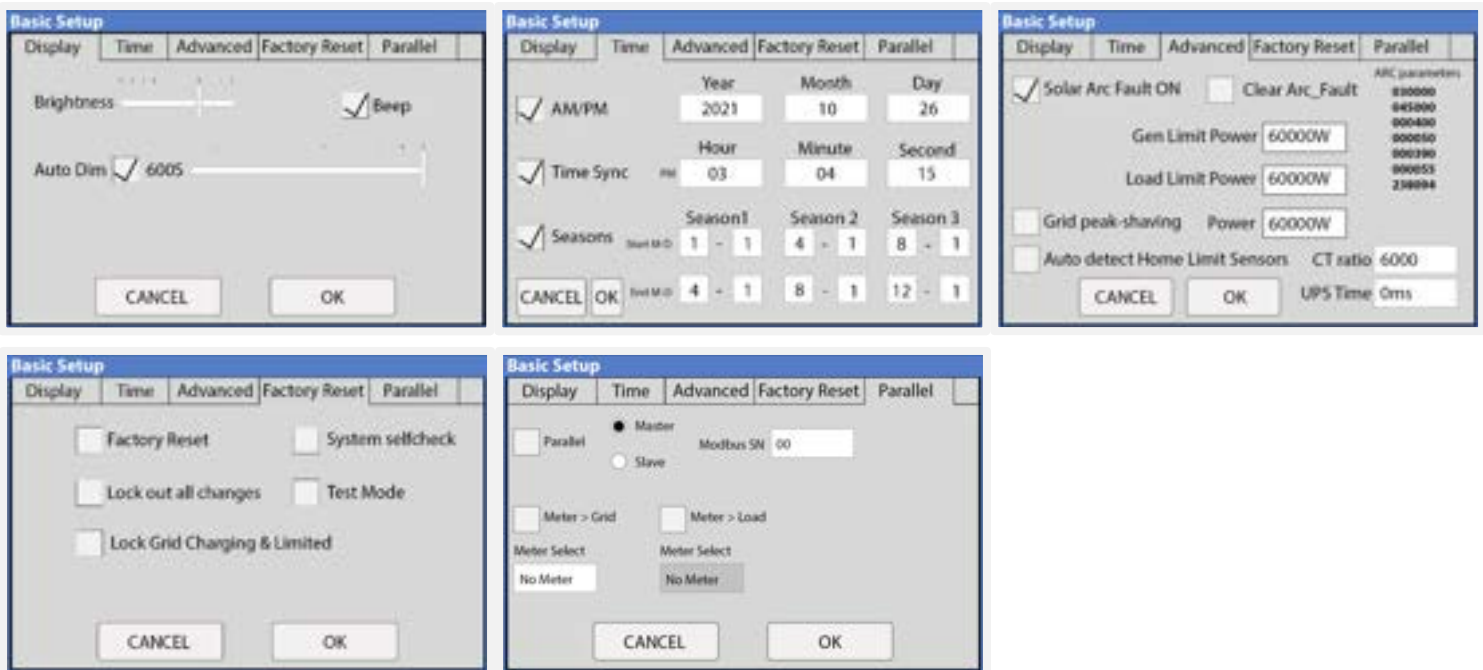

Display

Brightness: Brightness adjustment (+, -).

Auto Dim: ⚠️ Must be enabled at all times to validate the warranty of the LCD screen.

Beep: Enable / disable the alarm sound.

Time

Time Sync: Automatically syncs with the internet for daylight saving time changes (Enabling "Time sync" is recommended).

Seasons: Setup and customize the seasons for TOU.

Advanced

Solar Arc Fault ON: Enables Arc fault detection algorithm on the MPPTs.

Clear Arc Fault: Command to clear an Arc Fault.  It must be executed manually every time the system detects an F63 Arc_Fault alarm. See section 8.1 "Sol-Ark Error Codes" for more detail.

Gen Limit Power: Limits the power drawn from the "GEN" AC source. The inverter will reduce battery charge when value is reached.

Load Limit Power: Sets a limit to the total "LOAD" output power. The max output power of the inverter is programmed by default.

Grid-Peak Shaving: Sets a "GRID" consumption threshold that allows use of battery backup power during peak demand. External CT sensors are required. Peak shaving can be used on a generator provided it is wired to the "GRID" terminal.

Auto detect home Limit Sensor: Detects and auto-corrects the polarity of the CTs. See section 2.9 for details.

CT Ratio: Specifies the transformation ratio of the CT. Default value of 6000:1  **DO NOT** change or warranty will be voided.

UPS Time: Backup transfer time to essential loads upon grid disconnection. Default value of 5ms.

Factory reset

Restrictions: Changes to these settings must be previously authorized by Sol-Ark technical support agents.

Parallel

 Contact Sol-Ark technical support at support@sol-ark.com or (972) 575-8875 Ext. 2 before performing a multi-system installation.

Parallel: Enables communications between parallel inverters. "Master" and "Slave" inverters must be programmed.

MODBUS SN: Identification number for each system configured in parallel (1,2,3,4, n).

 See section 5 "Parallel Systems" for more information

3.4 Battery Setup

Batt

Batt Capacity: Specifies the capacity of the battery bank. Value expressed in Amp Hour (Ah).

 Batteries in series → Voltage adds up (V).

 Batteries in parallel → Capacity adds up (Ah).

Max A Charge: Sets the maximum charge current (A) rate to the batteries when charged from solar power → 50 max allowed. 100A max total if using both battery terminals.

Max A Discharge: Sets the maximum discharge current (A) rate from the batteries → 50 max allowed. 100A max total if using both battery terminals.

For Off-Grid systems, the battery bank will discharge 120% of this value for a 10 second surge before the inverter faults to prevent battery damage.

BMS Lithium Batt: Enables closed communications with lithium batteries. Serial Number (01,02, ...) must be specified according to communication protocol.

Use Batt V Charged: Displays battery charge in terms of voltage.

Parallel bat1&bat2: Must be checked when using both battery inputs for the same battery bank. When enabled, the inverter will expect a single battery communication source. Follow Battery Communication instructions from section 2.3.

Charge

Float V: Lower steady voltage at which the battery is maintained after being fully charged. Set according to manufacturer specs.

Gen Charge: Uses the "GEN" AC source to charge the battery bank.

- Start V:** Voltage at which the system will auto-start and allow a generator or AC source to charge the battery.
- Start %:** SOC at which the system will auto-start and allow a generator or AC source to charge the battery.
- A:** Maximum rate of charge to the batteries (per terminal) from the generator or AC source (DC amps). Set value according to the generator size.

Grid Charge: There are two scenarios in which this option is used:

- Grid connected to "Grid" input:** The inverter will limit the charge rate to the set value in "A" and the battery will charge to 100% SOC.
- Generator connected to "Grid" input:** It will be necessary to select " GEN connect to Grid input". The system will use "Start V", "Start%" and "A" conditions to charge the battery and stop charging at 95% SOC.  Adjustable upper limit if Time of Use is enabled.

Gen Force: Test function for generator auto-start. Enable and press OK to close normally open relay (CN2, pins 1,2) and force the generator on. Disable and press OK to disengage. The generator will not provide power during this test if grid power is available.

 The gen must be in automatic mode if applicable and must have a two-wire start (dry-contact, normally open) connected to the Sol-Ark.

Discharge

Shutdown: Battery voltage or % at which the inverter will shut down to protect the battery from an over discharge situation (battery symbol on the home screen will turn red).

Low Batt: Low battery voltage or % (battery symbol on the home screen will turn yellow). Stopping point for TOU.

Restart: Battery voltage or % at which AC output will resume after previously reaching "shutdown".

Batt Empty V: Sets the empty voltage and associates this voltage to 0% SOC. This value determines the lowest % SOC limit.

BMS_Err_Stop: Enables system stop when there is loss of battery communications.

 Continuous GEN input/output of 180A. **DO NOT EXCEED.**

Smart Load



- This mode uses the "GEN" input as a load output that delivers power when the battery exceeds a user programmable threshold or when the Sol-Ark is connected to the grid.
- When " Use gen input as load output" is enabled, the "GEN" input turns into an output to power high-power loads such as a water heater, irrigation pump, AC unit, pool pump, or any other load.
- When " On Grid always on" is enabled, the "GEN" terminal will always output power as long as the grid is connected, regardless of battery charge.

Smart Load OFF Batt: Battery voltage or % at which the "GEN" terminal will stop outputting power.

Smart Load ON Batt: Battery voltage or % at which the "GEN" terminal will start outputting power.

Solar Power (W): Amount of PV production needed before "GEN" terminal starts outputting power.

AC Coupling Settings - (For AC Coupled Input)

-  Grid-tied systems with AC coupled solar arrays must have " Grid Sell" enabled. Ensure you are allowed to sell back to the grid.
- To use the "GEN" terminal as an AC coupling input for micro inverters or string inverters, enable " For AC Coupled Input to Gen".
-  In off-grid systems, the Sol-Ark will use frequency shifting to control the AC coupled solution based on the battery SOC. The meaning of "Smart Load OFF Batt" and "Smart Load ON Batt" will change in this mode.

Smart Load OFF Batt: The % SOC at which the AC coupled inverters turn OFF.  90% recommended.

Smart Load ON Batt: The % SOC at which the AC coupled inverters turn ON.  80% recommended.

3.5 Limiter



Limiter

The Sol-Ark 60K-3P-480V inverter will simultaneously utilize different available power sources to satisfy load demand in the electrical service panels (essential loads panel / main service panel). The following work modes allow the user to determine how power is generated and utilized.

Grid Sell

Grid Sell: The inverter will produce as much power as it has available from PV array according to the programming. The maximum power that can be generated from DC coupled arrays and sold to the grid is 60,000W.

General description:

- This mode allows the inverter to sell back power generated from the solar arrays up to a programmable limit.
- The inverter will only measure loads connected to the "LOAD" terminal.
- The inverter will measure all power in / out of the "GRID" terminal as grid either consumption (+) or grid sell back (-).

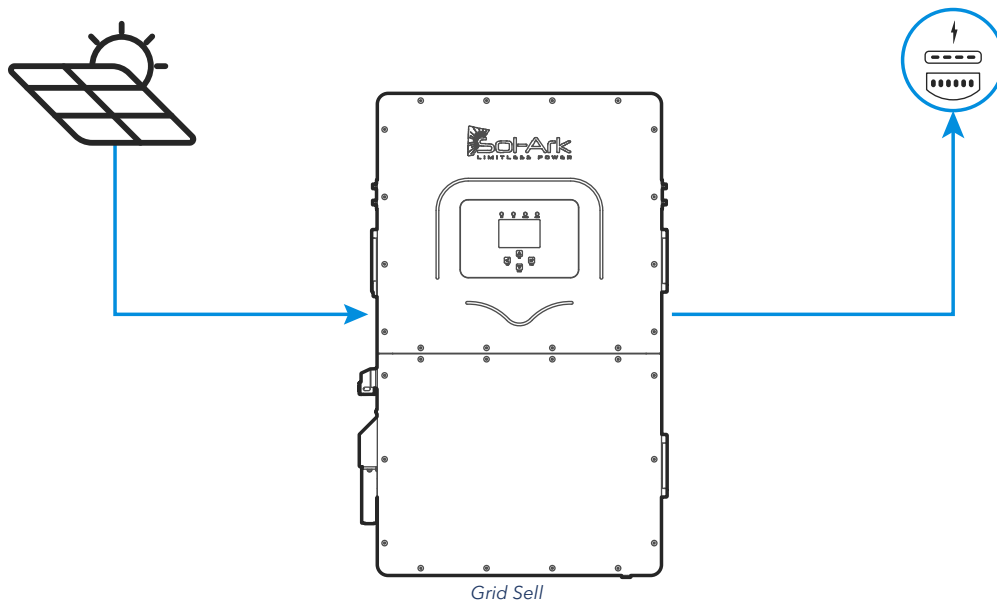

Limited Power to Home

! This work mode **REQUIRES** batteries

Limited Power to Home (Meter Zero): This mode limits the energy produced by the inverter to satisfy the total demand (essential loads panel + main service panel). In this mode, the inverter delivers power to the "LOAD" terminal (essential loads panel) + the "GRID" terminal (main service panel). CT sensors **MUST** be installed. These sensors measure load consumption in the main service panel to offset total load demand and prevent selling to the utility. This system work mode is useful for users that don't have a permit to sell back. See section 2.9 "Limit Sensors" for proper external CT installation.

General description:

- Power is delivered to all home loads without selling excess solar to the grid. This mode is suitable for systems where selling to the utility grid is not allowed.
- External CT sensors are **required** for proper operation.
- Monitored loads will be the addition of the main service panel + essential loads panel.
- Energy Priority:** 1. Solar PV Power | 2. Grid Power | 3. Batteries | 4. Generator

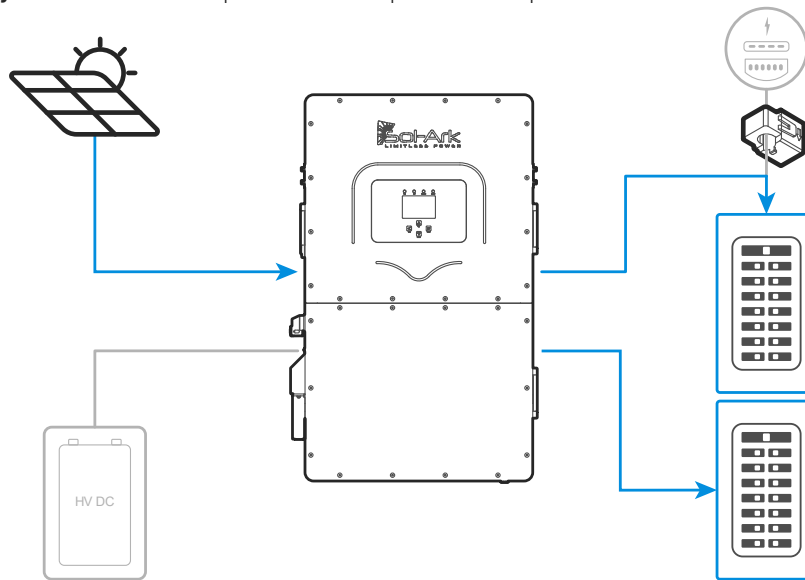

Limited Power to Home

Limited Power to Home + Grid Sell: This mode will NOT limit solar production to home demand. In this mode, the inverter delivers power to the "LOAD" terminal (essential loads panel) + excess power to the "GRID" terminal (main service panel AND grid). The Sol-Ark will monitor grid sell and load consumption simultaneously (with +/- 3% error from CT sensors). The CT sensors **MUST** be installed. The inverter will sell excess solar power up to a programmable limit. See section 2.9 "Limit Sensors" for proper external CT placement.

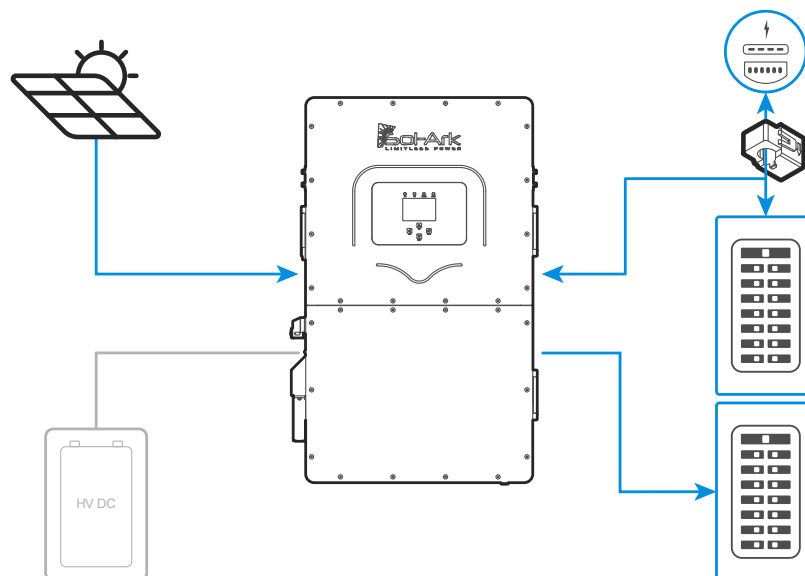

Limited Power to Home + Grid Sell

Limited Power to Load

! This work mode **REQUIRES** batteries

Limited Power to Load: This mode limits the solar production to cover "LOAD" demand (essential loads panel) exclusively. In this mode, the system disregards loads in the main service panel and will not deliver power to the "GRID" terminal.

General description:

- Power is limited to the "LOAD" demand. It will **NOT** produce more power than necessary.
- Power will **NOT** be delivered to the "GRID" terminal (NO grid sell).
- Monitored loads will be exclusive to the essential loads panel.
- This mode is recommended for off-grid applications.
- Energy Priority:** 1. Solar PV Power | 2. Grid Power | 3. Batteries | 4. Generator

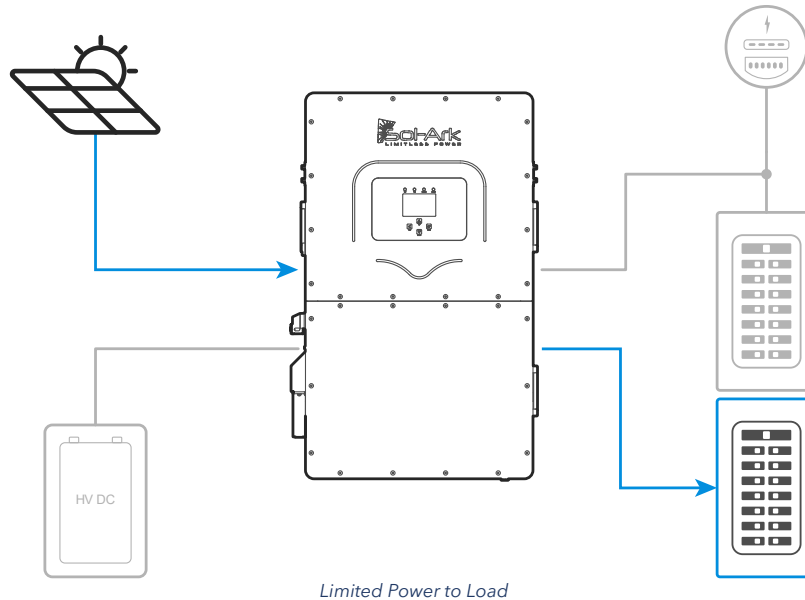

Limited to Load + Grid Sell: This mode will NOT limit solar production to "LOAD" demand. The inverter delivers power to the "LOAD" terminal (essential loads panel) + excess power to the "GRID" terminal (main service panel AND grid), however it will ONLY track "LOAD" demand and sell excess solar up to a programmable limit. "GRID" loads cannot be measured, only the total output through the "GRID" terminal. This mode is recommended for single inverter systems or for whole-site backup installations.

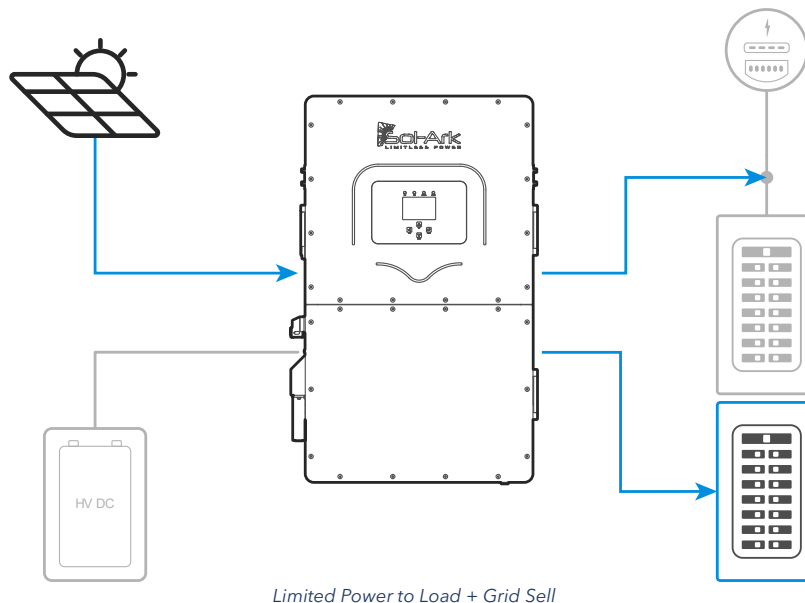

Time of Use

Time Of Use (TOU): This mode combined with “Limited Power to Home” or “Limited Power to Load” allows the use of battery backup power to reduce consumption from the grid during specific time intervals. Battery power will cover load demand at a programmable power rate “**Power(W)**” down to a programmable “**Batt (V / %SOC)**”. You can configure six different time intervals over a 24-hour period to cover a wide range of battery discharge or charge behaviors.

General description:

- Uses battery power to reduce the power consumption during user defined time intervals.
- Power (W) dictates the rate at which the battery discharges to assist with load demand.
- Batt (V or %) dictates the lower discharge limit or upper charge limit.
- Energy Priority:** 1. Solar PV Power | 2. Batteries (down to programmed discharge V or %) | 3. Grid Power | 4. Generator.

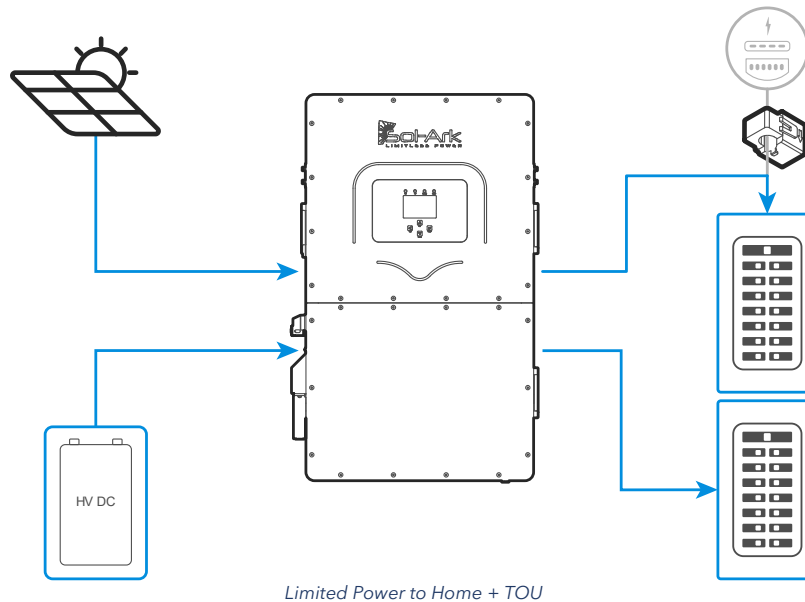

Time: Programmable time intervals over a 24h period. All time slots **MUST** follow chronological order and must be programmed.

Power(W): Sets the maximum discharge rate of the battery during the corresponding time slot.

Batt: V or % used to specify a lower discharge limit or upper charge limit whenever “ Charge” is enabled. **!** Grid-tied systems will not allow TOU to discharge lower than “**Low Batt V/%**”. Off-grid systems allow TOU discharge down to “**Shutdown V/%**”.

Charge: During the hours selected, it is allowed to charge batteries from an external AC source up to a programmed voltage or %. If the external AC power source is a generator, the “Start V” or “Start %” condition must be fulfilled first. If available, the solar array will always charge the batteries at 100% regardless of “ Charge” in TOU.

Sell: Allows batteries to discharge and sell power to the grid at the programmable “Power(W)” rate. “ Grid Sell” **MUST** be enabled.

! Do **NOT** enable “Charge” and “Sell” at the same time

Other

GEN Connect to Grid Input: Specifies when a generator is connected to the “GRID” terminal.

Zero Export Power: Minimum power imported from the grid. Helps avoid selling back by ensuring constant grid consumption. The value can be set between 1 - 100W (recommended 20W).

Batt First: **!** Default and recommended option. Sets the solar power priority of the system to charge batteries first. Do NOT change unless instructed by Sol-Ark technical support.

Load First: Sets the solar power priority of the system to cover loads demand first and deliver remaining power to batteries. **!** Only recommended for very specific situations.

3.6 Grid Setup

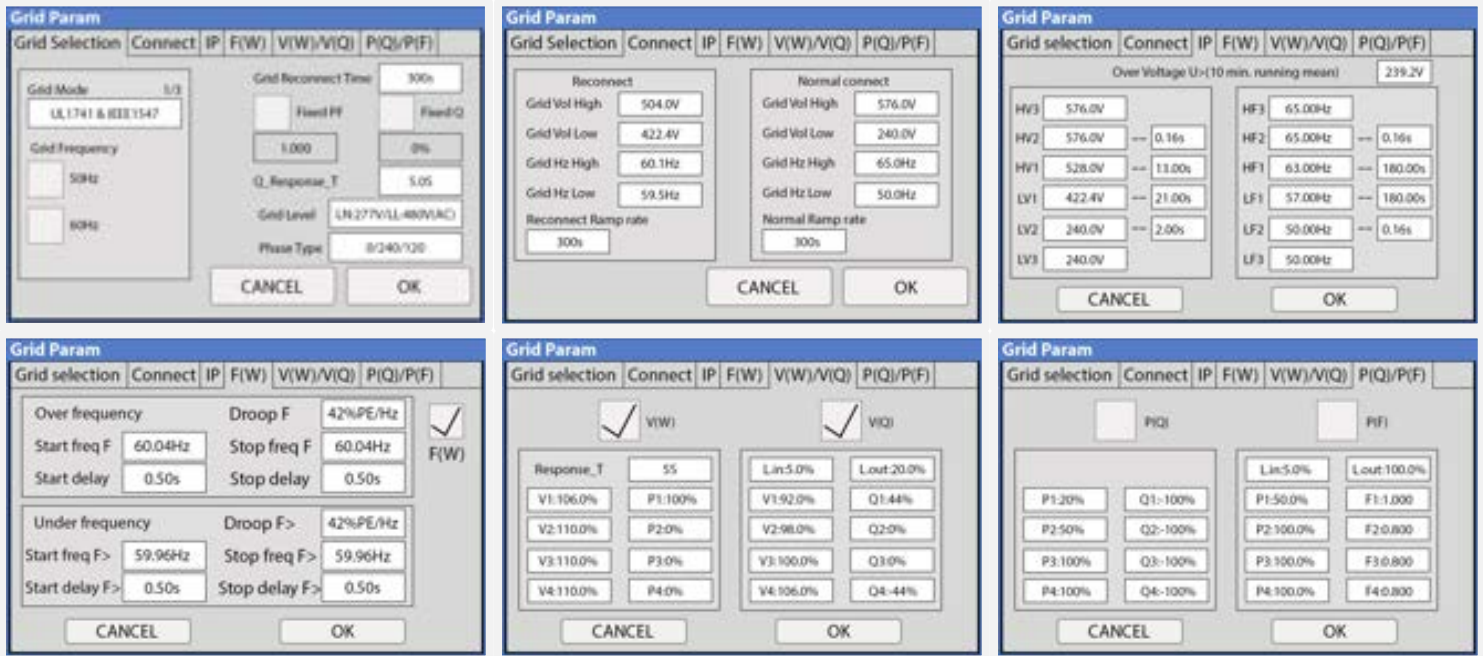

Grid Selection

Grid Mode: Tap and use navigation arrows to cycle through different grid modes:

- General Standard:** Applies general grid interconnection standards. Enables grid frequency and voltage adjustments. (Useful for off-grid applications with backup generators).
- UL1741 & IEEE1547:** Applies UL 1741 and IEEE 1547 grid interconnection requirements and standards.
- CPUC RULE21:** Applies California's grid interconnection requirements and standards.
- SRD-UL-1741:** Applies UL 1741SB grid interconnection requirements and standards.

Grid Frequency: Frequency of the AC sine wave.

Grid Reconnect Time: The amount of time in seconds the inverter will wait before reconnecting to the grid.

Fixed PF: Allows for power factor correction, ±0.8 to 1.0

Fixed Q: Allows for power factor correction based on desired reactive power percentage.

Grid Level: Tap and use navigation arrows to cycle through different nominal grid voltage levels. ⚠️ Grid level must be selected according to nominal grid voltage.

- LN:277VAC LL:480VAC
- LN:230VAC LL:400VAC
- LN:220VAC LL:380VAC

Phase Type: Tap and use navigation arrows to specify phase sequence.

- 0/240/120: Positive sequence A-B-C
- 0/120/240: Negative sequence A-C-B

Connect

Reconnect: Parameters used to determine an allowable range of frequency and voltages to dictate a reconnection to the grid after initial grid loss. Frequency and voltages must be within these margins during Grid Reconnect Time to allow grid reconnection.

ⓘ Parameters will be set automatically based on selected grid mode compliance, unless "General Standard" is selected.

Normal connect: Parameters used to determine an allowable range of frequency and voltages to retain connection to the grid following a reconnect and normal operation.

ⓘ Parameters will be set automatically based on selected grid mode compliance, unless "General Standard" is selected.

Reconnect Ramp Rate: Reconnection power ramp time in seconds.

Normal Ramp Rate: Startup power ramp time in seconds.

IP

HV1/HV2/HV3: Overvoltage protection point.

LV1/LV2/LV3: Undervoltage protection point.

HF1/HF2/HF3: Over frequency protection point.

LF1/LF2/LF3: Under frequency protection point.

F(W)

F(W): Enables the use of Frequency-Watt. The Sol-Ark regulates its power output to the grid as a function of the frequency to support grid stabilization during over and under-frequency conditions.

Droop F: Percentage of inverter's nominal power increase / decrease per Hert (Hz).

Start freq F: Frequency at which the inverter will start decreasing active power by the programmed Droop F percentage.

Stop freq F: Frequency at which the inverter will stop decreasing active power by the programmed Droop F percentage.

V(W) / V(Q)

V(W): Enables the use of Volt-Watt. The Sol-Ark regulates active power output to the grid as a function of voltage to support stabilization during over and under-voltage conditions.

V(Q): Enables the use of Volt-VAr. The Sol-Ark regulates reactive power output to the grid as a function of the voltage to support stabilization during over and under-voltage conditions.

V, P & Q: Percentage of nominal grid voltage (V) to which the Sol-Ark will reduce its active power (P) or reactive power (Q).

P(Q) / P(F)

P(Q): Enables the use of Watt-VAr to regulate reactive power output according to programmable active power parameters.

P(F): Enables PF regulation according to programmable active power parameters.



Follow electrical grid code before changing grid settings

4. Installation Tips

Off-Grid Installation Tips

1. Limit sensors (CTs) are not required for completely off-grid installations unless using **"Grid Peak Shaving"** for a generator connected to the **"GRID"** terminal.
2. Connecting generators to the **"GRID"** terminal is recommended to facilitate the integration "GEN" connected service panel. This setup enables the utilization of the **"Smart Load"** function.
3. There is no need for a transfer switch. Connect the "LOAD" output to the main panel.
4. **DO NOT** use "Grid Sell" mode when Off-Grid. **ONLY "Limited Power to Load"** (default).
5. When using a Generator in an Off-Grid situation, it is recommended to change the "Grid Mode" to **"General Standard"** and a **"Grid Reconnect Time"** to 30 seconds. See section 2.5 "Integrating a Generator" for detailed instructions.
6. The Auto Gen-Start activates when the battery voltage (V) or percentage (%) reaches the pre-set "Start V / %" value. Subsequently, the generator will sustain the charging process until the batteries reach approximately 95% capacity. ! This is a non-modifiable upper limit unless Time of Use is enabled and programmed.
7. If planning on integrating a wind turbine, a $\geq 600V$ charge controller with a dump load **MUST** be incorporated to prevent battery overcharge. This charge controller must be connected directly to the battery bank.
8. Remember to set the battery capacity and reasonable charge/discharge rates.

Grid-Tie and No Battery Install Tips (Passthrough mode)

1. Check the **" No Battery"** setting: ⚙️ → Battery Setup → Batt → No Battery . The inverter will fault momentarily.
2. ! A complete **Power Cycle IS REQUIRED** when changing the battery mode to **"No Battery"** (see section 2.12 "Power cycle Sequence" for detailed instructions).
3. Enable **" Grid Sell"**: ⚙️ → Limiter → Grid Sell. Make sure to disable all other modes.
4. Tap the battery icon to access the "Details Screen" and verify grid parameters and power import / export.

4.1 Battery Charge Controller

4-Stage Charging

The MPPT has a 4-stage battery charging algorithm for rapid, efficient, and safe battery charging. The next figure shows the stage sequence.

Bulk Charge Stage

In the Bulk Charge stage, the battery is not at a 100% state of charge and has not yet reached the Absorption voltage setpoint. The controller will deliver 100% of available solar power to recharge the battery.

Absorption Stage

When the battery has reached the absorption voltage setpoint, the Sol-Ark inverter uses constant-voltage regulation to maintain battery voltage at the absorption setpoint, preventing overheating and excessive battery gassing. The battery is allowed to come to a full state of charge at the absorption voltage setpoint. Absorption lasts until the battery charge amperage (A) rate reaches 2% of the programmed capacity (Ah).

Float Stage

After the Absorption stage charges the battery fully, the MPPT reduces the battery voltage to the float voltage setpoint. The Float stage provides a meager rate of maintenance charging while reducing the heating of a fully charged battery. The purpose of the Float stage is to protect the battery from long-term overcharge.

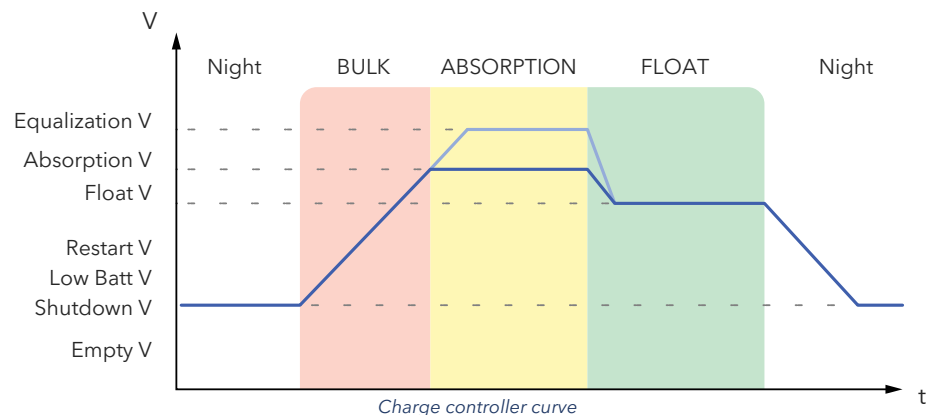

4.2 Grid Compliance Settings

HECO Grid Compliance Verification for Sol-Ark

In cases where HECO compliance requirements are mandated, it is essential to program the following grid parameters in accordance with the HECO specifications. Follow the next GUI screens, program the settings, and verify alignment with HECO compliance.

Grid Param

Grid Selection	Connect	IP	F(W)	V(W)/V(Q)	P(Q)/P(F)
Grid Mode: 1/3					
5RD-LL-1741					
Grid Frequency: 50Hz					
<input checked="" type="checkbox"/> 60Hz					
Grid Reconnect Time: 300s					
<input checked="" type="checkbox"/> Fixed PF					
-0.900					
Fixed Q					
0%					
Q_Response_T: 105					
Grid Level: LL:277V/LL:480V(AC)					
Phase Type: 0/240/120					
CANCEL		OK			

Grid Param

Grid Selection	Connect	IP	F(W)	V(W)/V(Q)	P(Q)/P(F)
Reconnect					
Grid Vol High	504.0V				
Grid Vol Low	422.4V				
Grid Hz High	60.1Hz				
Grid Hz Low	59.5Hz				
Reconnect Ramp rate	300s				
Normal connect					
Grid Vol High	576.0V				
Grid Vol Low	240.0V				
Grid Hz High	65.0Hz				
Grid Hz Low	50.0Hz				
Normal Ramp rate	300s				
CANCEL		OK			

Grid Param

Grid selection	Connect	IP	F(W)	V(W)/V(Q)	P(Q)/P(F)
Over Voltage U>(10 min. running mean) 239.2V					
HV3	576.0V				
HV2	576.0V	0.16s			
HV1	528.0V	13.00s			
LV1	422.4V	21.00s			
LV2	240.0V	2.00s			
LV3	240.0V				
HF3	65.00Hz				
HF2	65.00Hz	0.16s			
HF1	63.00Hz	180.00s			
LF1	57.00Hz	180.00s			
LF2	50.00Hz	0.16s			
LF3	50.00Hz				
CANCEL		OK			

Grid Param

Grid selection	Connect	IP	F(W)	V(W)/V(Q)	P(Q)/P(F)
Over frequency					
Start freq F	60.04Hz				
Start delay	0.50s				
Droop F	42%PE/Hz				
Stop freq F	60.04Hz				
Stop delay	0.50s				
Under frequency					
Start freq F>	59.96Hz				
Start delay F>	0.50s				
Droop F>	42%PE/Hz				
Stop freq F>	59.96Hz				
Stop delay F>	0.50s				
CANCEL		OK			

Grid Param

Grid selection	Connect	IP	F(W)	V(W)/V(Q)	P(Q)/P(F)
<input checked="" type="checkbox"/> V(W) <input checked="" type="checkbox"/> V(Q)					
Response_T: 55					
V1:106.0%	P1:100%				
V2:110.0%	P2:0%				
V3:110.0%	P3:0%				
V4:110.0%	P4:0%				
Lin:5.0% Lout:20.0%					
V1:92.0%	Q1:44%				
V2:98.0%	Q2:0%				
V3:100.0%	Q3:0%				
V4:106.0%	Q4:44%				
CANCEL		OK			

Grid Param

Grid selection	Connect	IP	F(W)	V(W)/V(Q)	P(Q)/P(F)
<input type="checkbox"/> P(Q) <input type="checkbox"/> P(F)					
Lin:5.0% Lout:100.0%					
P1:20%	Q1:100%				
P2:50%	Q2:100%				
P3:100%	Q3:100%				
P4:100%	Q4:100%				
P1:50.0% F1:1.000					
P2:100.0%	F2:0.800				
P3:100.0%	F3:0.800				
P4:100.0%	F4:0.800				
CANCEL		OK			

Parallel Systems Sol-Ark 60K-3P-480V @ 277/480V 3-Phase

# of inverters in parallel	Continuous output power (kW)	Cont. Grid Pass Through Current (A)	Peak power 10 sec (kVA)
1	60	180	90
2	120	360	180
3	180	540	270
4	240	720	360
5	300	900	450
6	360	1080	540
7	420	1260	630
8	480	1440	720
9	540	1620	810
10	600	1800	900

5.2 Parallel Systems Programming Sequence

1. Program each inverter for parallel operation: ⚙️ → Basic Setup → Parallel → "☑ Parallel"
2. Assign a "Master" inverter, **Modbus SN: 1**
3. Assign all other units as "Slave" | **Modbus SN: 2,3,4...**etc.
4. Connect communication cables between the inverters using the RJ45 cable (yellow ethernet cable) in daisy-chain configuration between ports: "Parallel_1" or "Parallel_2" from Master to Slave / Slave to Slave.
5. Perform a power cycle (see section 2.12 "Power Cycle Sequence" for power cycle sequence instructions).
6. Once the power cycle is completed, turn on the "Slave" units **FIRST**. Then turn ON the "Master" **LAST**.
7. Inverters will likely fault momentarily with F29 and F41 codes until all inverters are ON.

! When integrating a generator, it must be connected to all the systems in parallel. The inverter assigned as "Master" will control the two-wire start feature

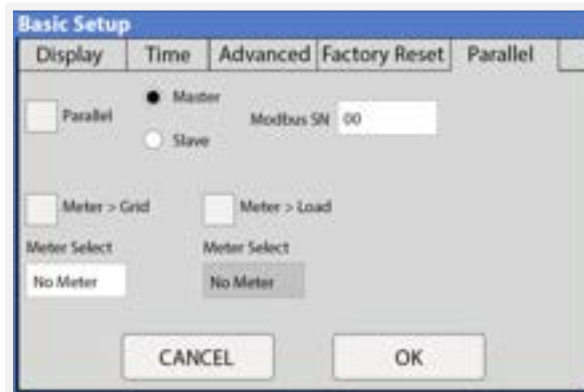

Parallel setup tab

! If an inverter goes into a fault state, all other units will stop and follow. The system will automatically self-reboot. If the system faults 5 consecutive times, it will stop completely and it will require a manual restart. See section 2.12 "Power cycle sequence" for detailed instructions.

5.3 Troubleshooting Phase Sequence

⚠ If the screen of the Sol-Ark inverter shows the error shown below, ensure the phase sequence follows the “Phase Type” programmed under ⚙ → *Grid Setup* → *Grid Selection*. The message “Grid Phase Wrong” is displayed when the inverter does not detect the correct phase sequence. This situation can cause overloads faults in the system (F18, F26, F34) even with the “LOAD” disconnected and **WILL CAUSE DAMAGE** to the equipment if it is not corrected.

If the programmed phase type is “0/240/120”, ensure the wiring follows a positive sequence **A-B-C**. If the programmed phase type is “0/120/240” ensure the wiring follows a negative sequence **A-C-B**.

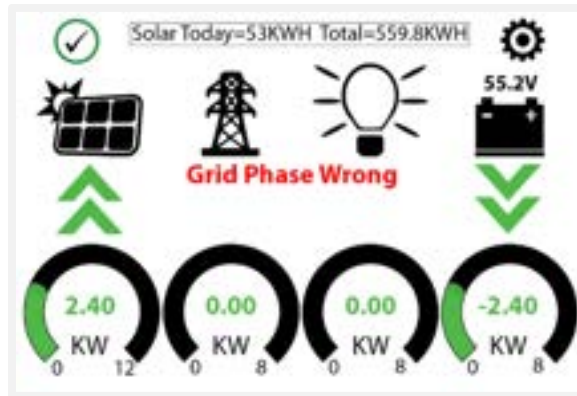

How to find an incorrect phase if prompted “Grid Phase Wrong”?

- Measure L-L voltages from “GRID” to “LOAD” terminals.
- Voltage between lines must be 0Vac.
- Measuring voltage different than 0Vac means the lines are not the same phase.

Be sure to check both “GRID” and “LOAD” terminal connections; both must be correct. If the error persists you will need to check your AC connection beyond the inverter and you will need to verify that the phases are correctly labeled from your meter.

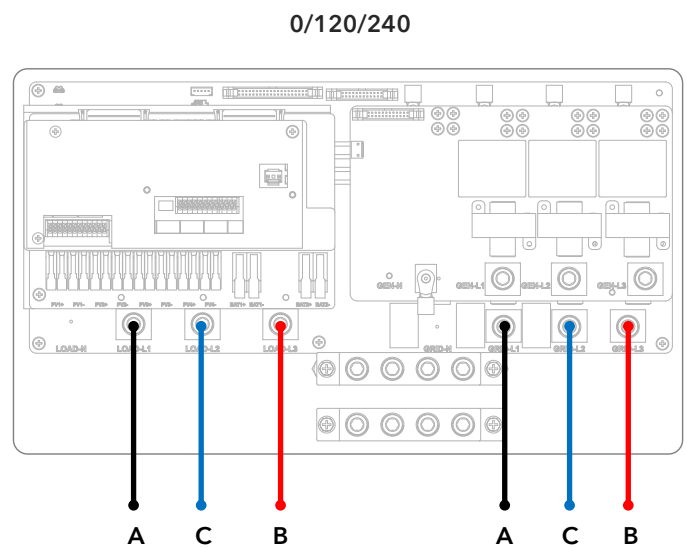
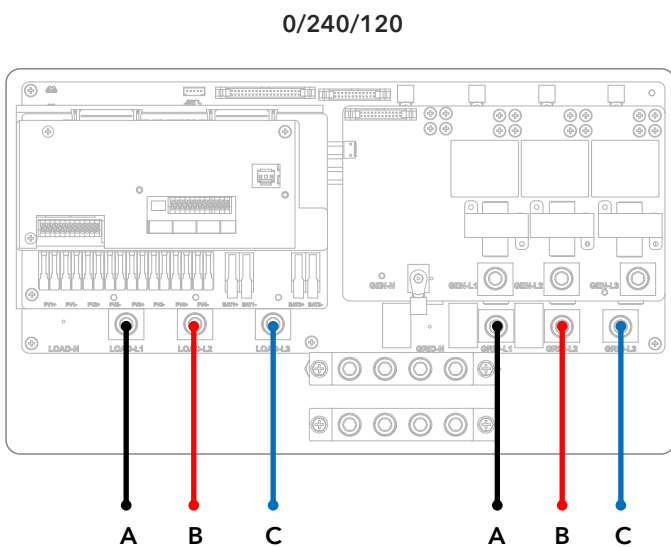

6. MySolArk: Remote Monitoring



"MySolArk" is a powerful and comprehensive tool designed for remote system monitoring of Sol-Ark inverters and solar systems. This remote monitoring solution offers detailed insights into energy generation and power consumption, allowing users to track system performance with great precision. MySolArk displays all relevant electrical data on easy-to-understand energy generation graphs, providing a comprehensive overview of electrical usage.

Beyond its monitoring capabilities, MySolArk offers users the flexibility to remotely adjust inverter settings, allowing them to seamlessly configure their system from any location. This ensures that users can fine-tune parameters to optimize performance effortlessly. With MySolArk, users can confidently manage their solar systems and inverters to ensure peak performance and efficiency at all times. Visit www.mysolark.com to access the desktop version of MySolArk.

6.1 MySolArk Setup Instructions

Connection to MySolArk through Ethernet

- A. Remove the plastic enclosure of the dongle by pressing the plastic latches with a flat screwdriver as shown in the figure below.
- B. Insert the ethernet cable through the plastic enclosure and connect the cable to the RJ45 port.
- C. Reassemble the dongle housing and plug the dongle into the Sol-Ark, securing it with screws. You will see solid red and green lights after a couple of minutes.
- D. Follow "STEP 1" instructions on the following page in order to create a plant on MySolArk.



Connection to MySolArk through Wi-Fi

- A. Plug the Wi-Fi dongle into the Sol-Ark DB-9 port.
- B. Use two M4X10 screws to secure the dongle to the port.
- C. Follow "STEP 1" through "STEP 3" in order to:
 - a. Create a plant on the MySolArk monitoring platform.
 - b. Connect the dongle to MySolArk through a Wi-Fi network.

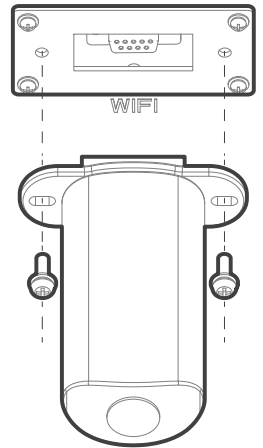

STEP 1: Create a "Plant" on MySolArk

- A. Download and install the "MySolArk" app for android or apple smartphones. QR codes are provided below.



Google Play Store



MySolArk



Apple App Store

B. Create a MySolArk account and login.

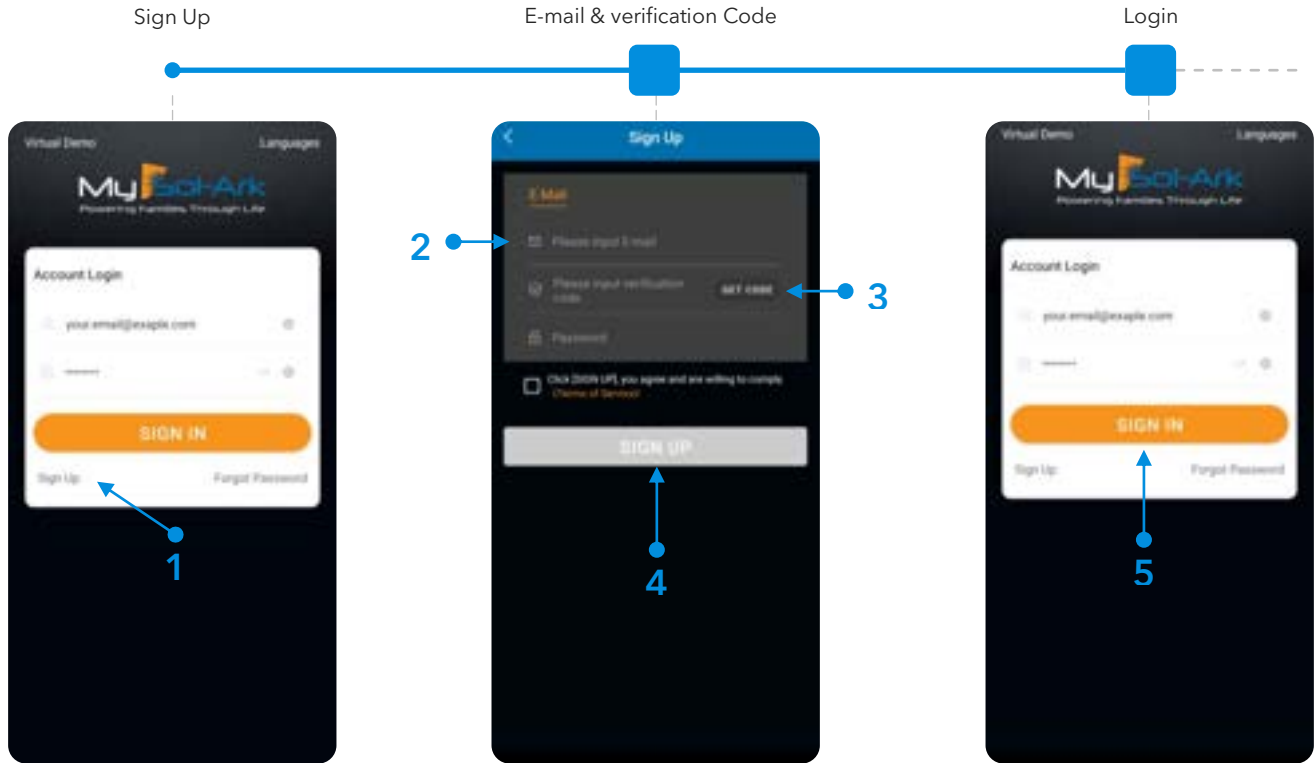

C. Create Plant.



For Installers

Installers are advised to first create the plant and configure the system before sharing it with the owner. Once the plant has been created and configured, the installer can share and grant manager permissions to the owner by navigating to "My Plants" → "... " → "Share" → "Add Account". The homeowner must create their own MySolArk account first.

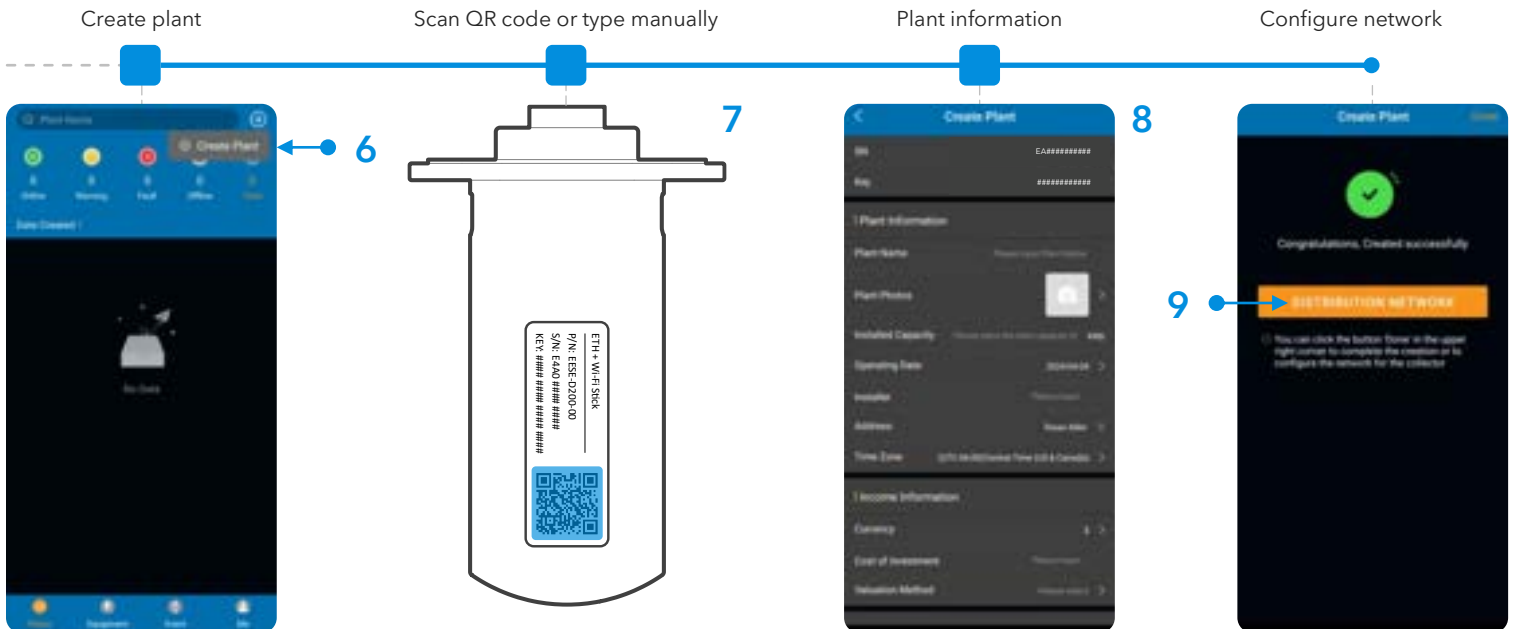

STEP 2: Configure Wi-Fi network through MySolArk

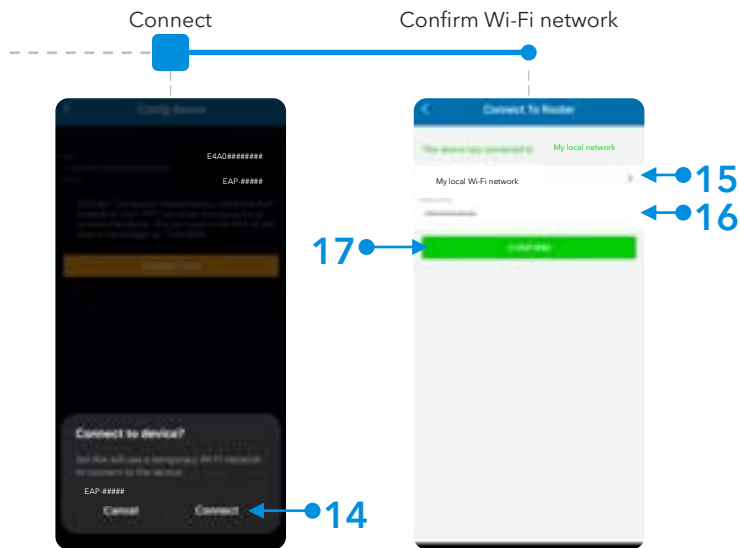
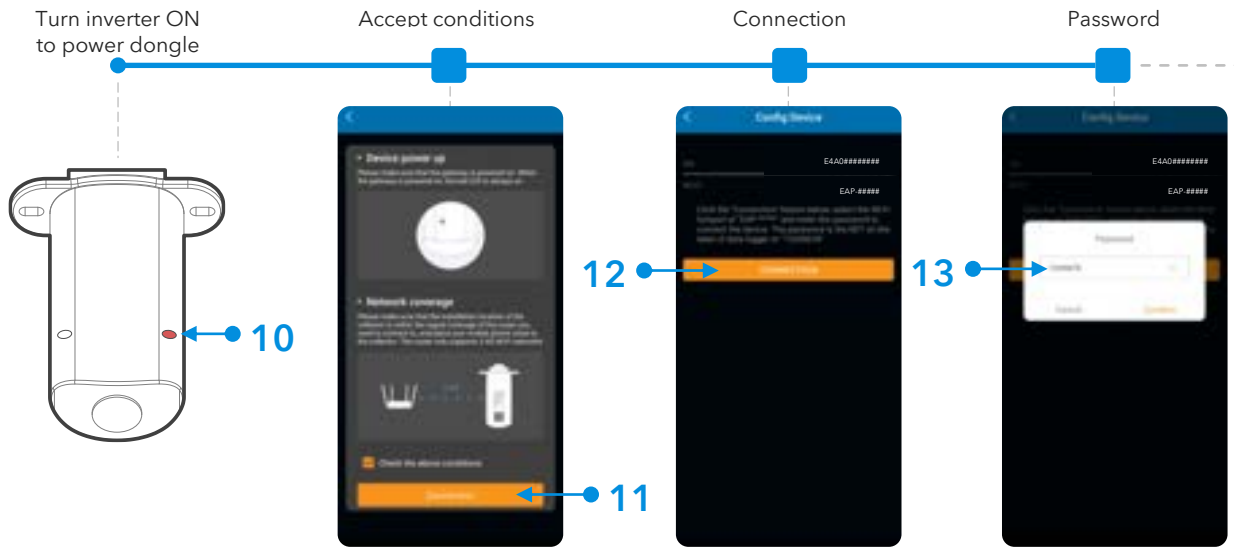

D. Configure Wi-Fi network.

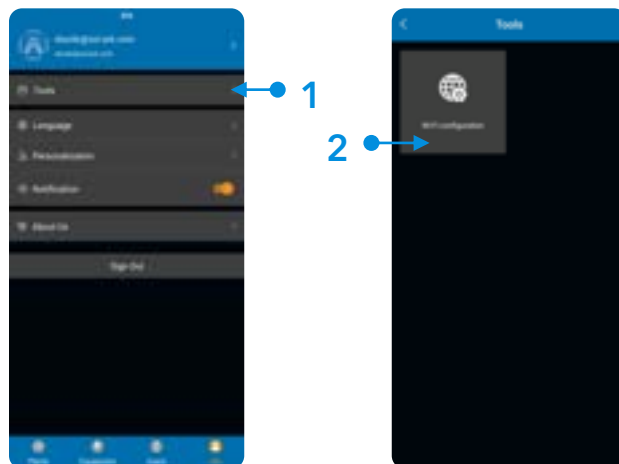

NOTE: The Wi-Fi configuration tool can be accessed at any other time by tapping "Me" at the bottom right corner, then "Tools" and finally "Wi-Fi configuration". STEP 3 shows an alternative method of connecting the Wi-Fi dongle to a local network through an IP address.



If the connection is a success, you will see the following LED indicators.

- o **SOLID** : Connected and powered by the Sol-Ark inverter.
- o **SOLID** : Connected to the router and to MySolArk.

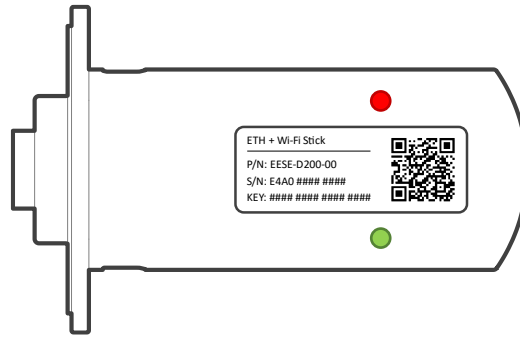

Wi-Fi dongle LED indicators





 Connecting the through the 10.10.10.1 IP address is only meant to provide internet access to the Wi-Fi dongle. **Users must still create a MySolArk account and must create a Plant.** Visit www.mysolark.com to access the desktop version of MySolArk.

6.2 LED Indicator and troubleshooting

When both the red and green LEDs on the Wi-Fi dongle are consistently illuminated, it signifies normal operation, while flashing indicates data transmission. If this isn't the case, reference the next table of LED indications for troubleshooting and corrective measures.

 **RED LED**: Device communication indicator.

 **GREEN LED**: MySolArk server communication indicator.

LED	State	Indication
	Initial flashing, then constant illumination	Normal communication.
	Initial flashing but no further illumination	Communication failure. Check proper device connection.
	LED not illuminating	Power supply or device is abnormal. Contact technical support.
	5 second illumination interval	Normal communication.
	1 flash every minute	Router not connected.
	3 flashes every minute	Connected to router but no internet access. Usually, a VPN or firewall issue. Ports 80 and 51100 must be enabled.
	4 flashes every minute	Device communication error. Contact support.
	2 synchronized flashes	Ethernet cable inserted
	3 synchronized flashes	Ethernet cable disconnected

7. Wiring Diagrams



The following diagrams are general use cases. Installers are reminded that adherence to local electrical codes and regulations is mandatory. While these diagrams offer general guidance, they may not encompass all variations and specifics required by local codes. Consult with relevant authorities and ensure compliance before proceeding with any installation. The diagrams presented herein are not exhaustive and should not be relied upon solely for permitting or warranty verification. Installers are encouraged to exercise caution, seek professional advice when necessary, and undertake installations with due diligence and in accordance with established electrical standards and regulations.

Sol-Ark 60K-3P-480V
Standard Wiring Diagram

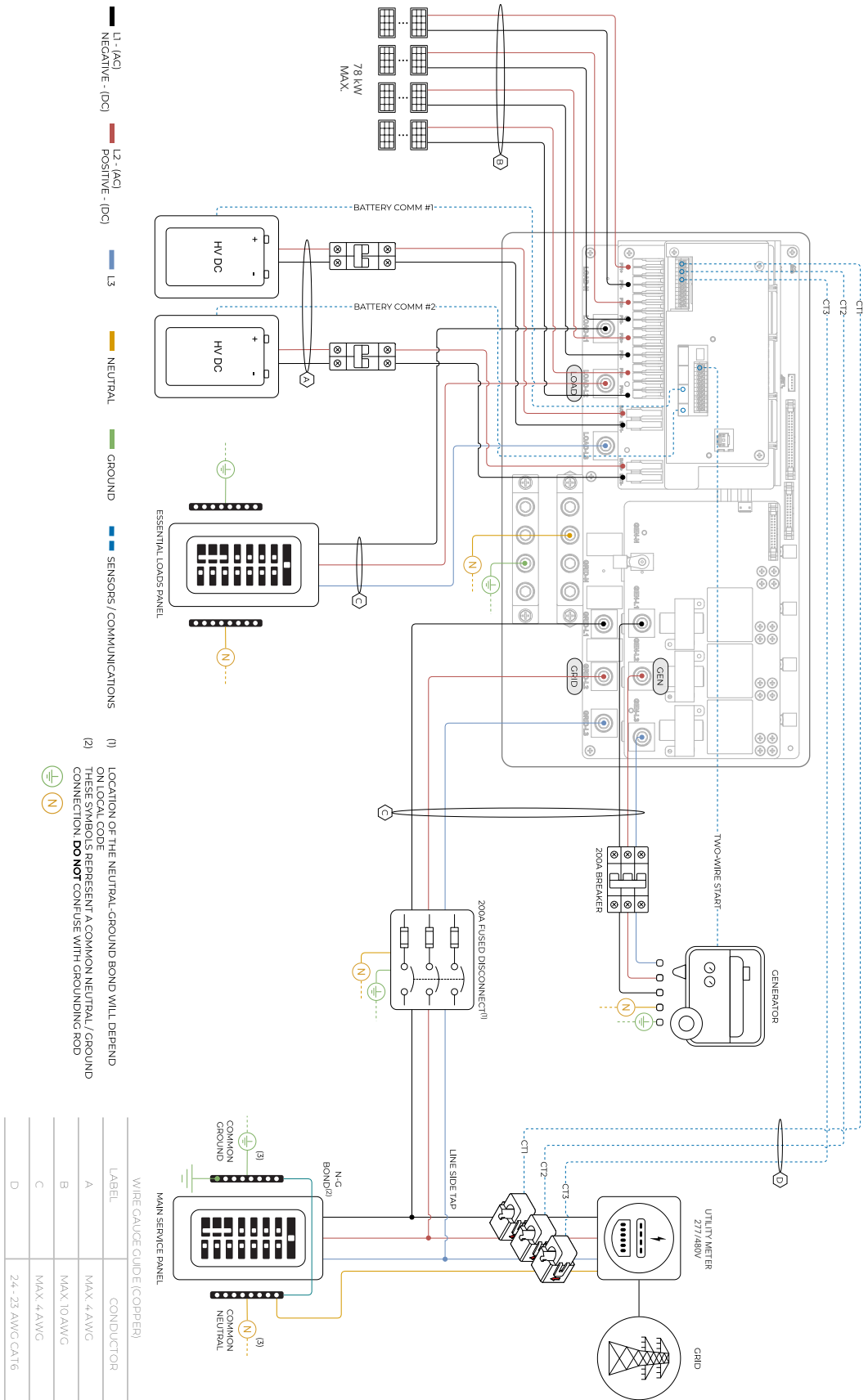

Diagram 01

Sol-Ark 60K-3P-480V
Standard Wiring Diagram - Off Grid

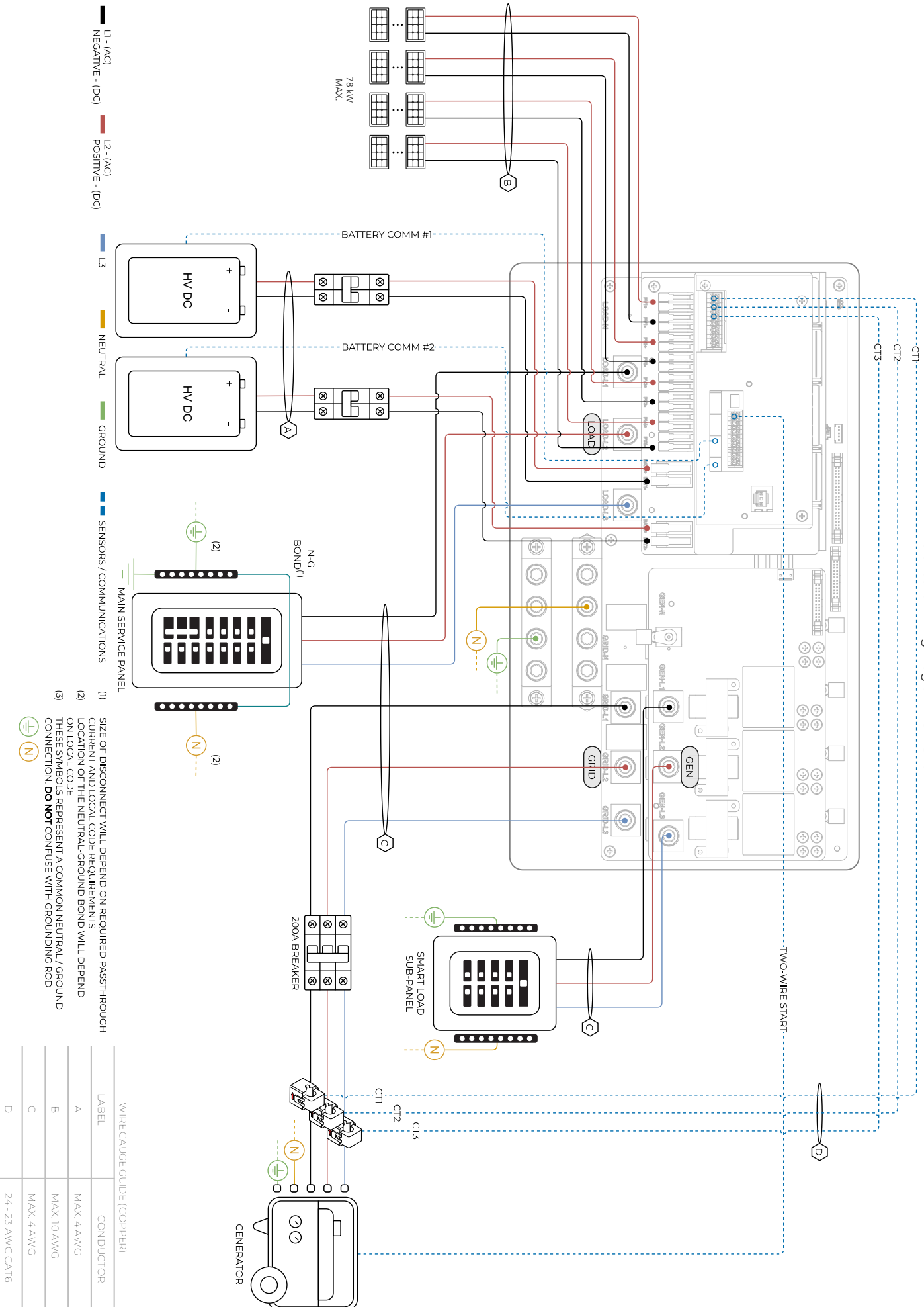

Diagram 02

Sol-Ark 60K-3P-480V
Standard Wiring Diagram - AC Coupling

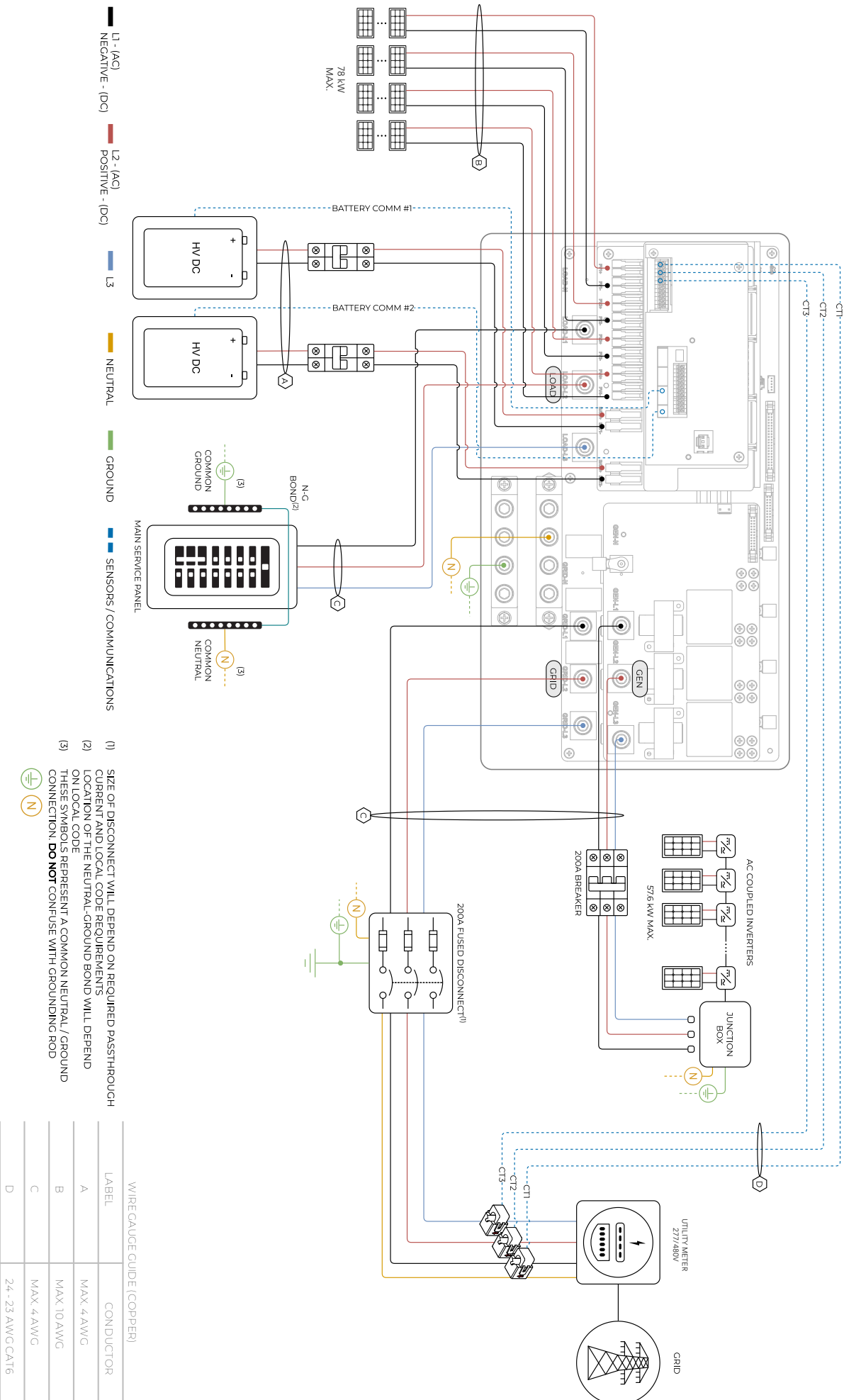

Diagram 03

Sol-Ark 60K-3P-480V
Standard Wiring Diagram - Bypass Transfer Switch

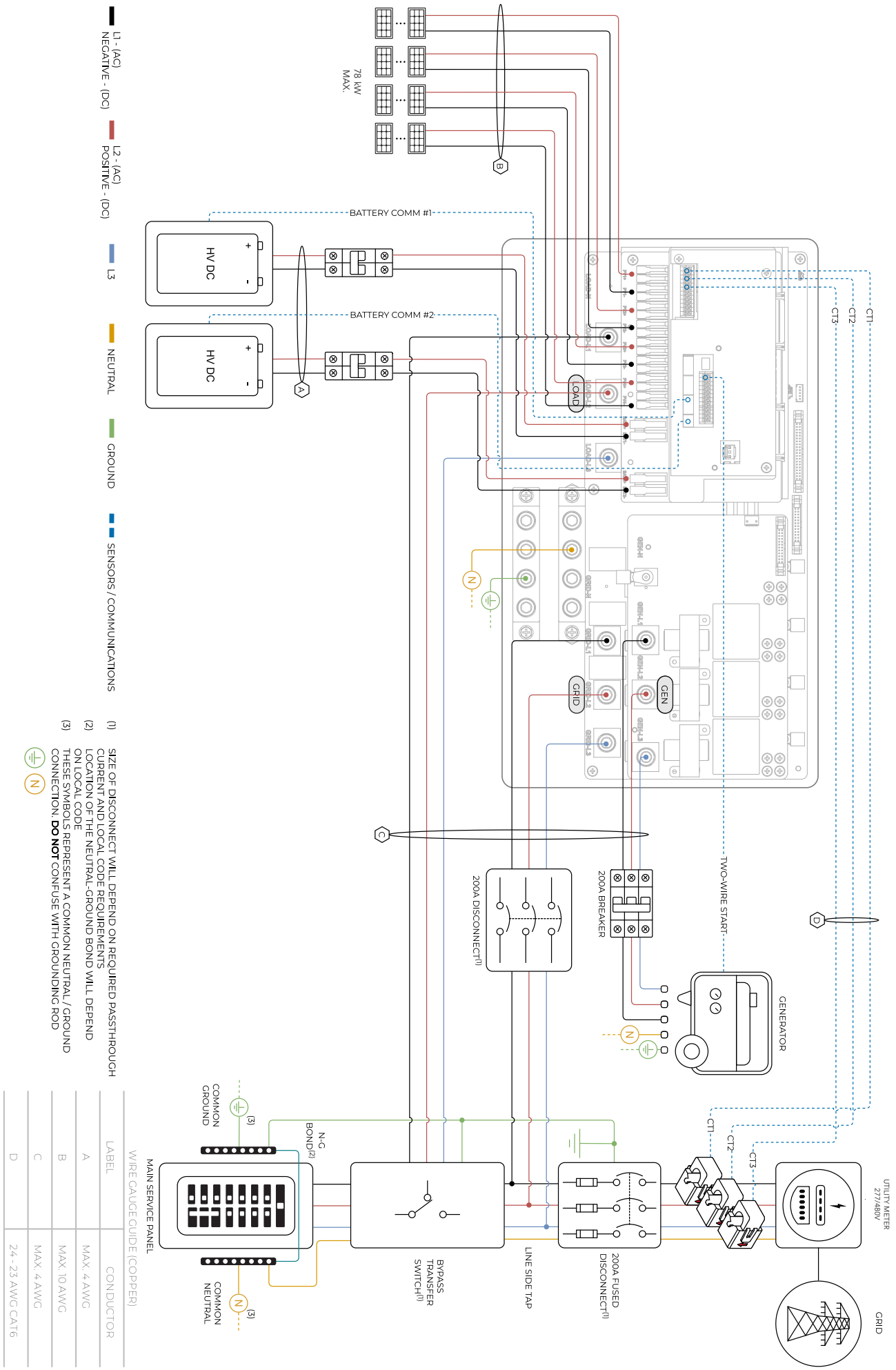
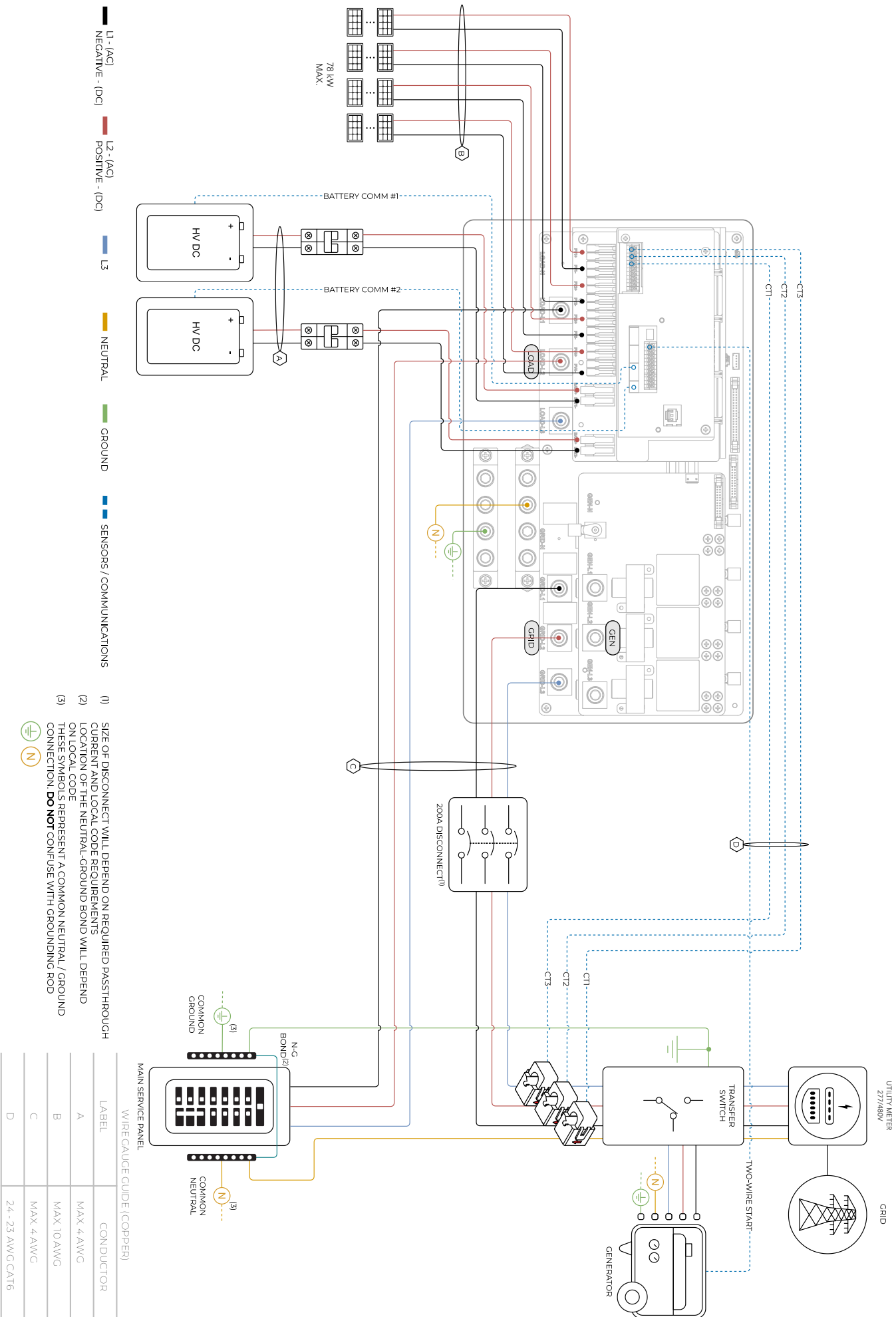
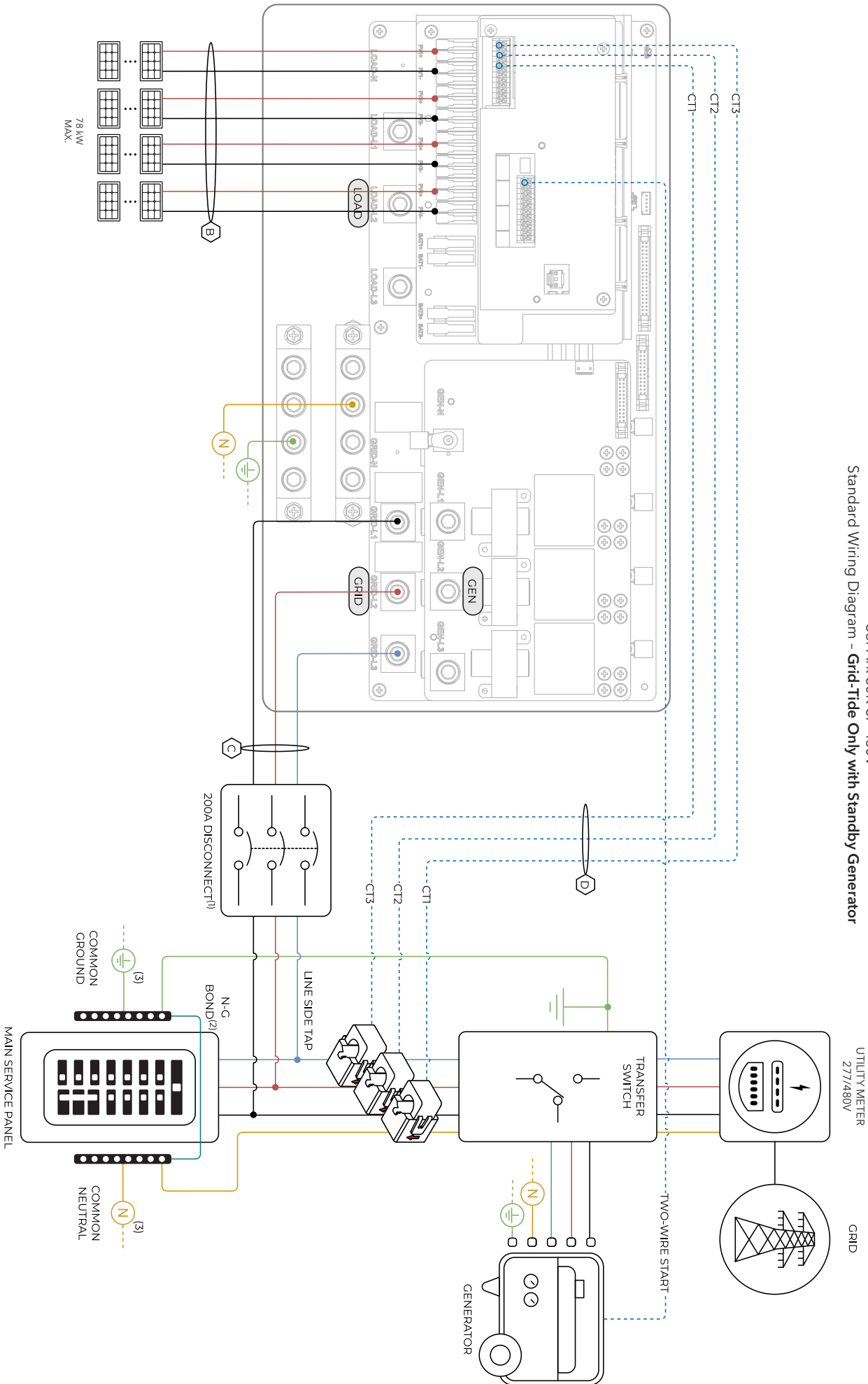

Diagram 04

Sol-Ark 60K-3P-480V Standard Wiring Diagram - Standby Generator



Sol-Ark 60K-3P-480V
Standard Wiring Diagram - Grid-Tide Only with Standby Generator



— L1 - (AC) POSITIVE - (DC)
— L2 - (AC) NEGATIVE - (DC)
— L3
— NEUTRAL
— GROUND
— SENSORS / COMMUNICATIONS

- (1) SIZE OF DISCONNECT WILL DEPEND ON REQUIRED PASTTHROUGH CURRENT AND LOCAL CODE REQUIREMENTS
- (2) LOCATION OF THE NEUTRAL-GROUND BOND WILL DEPEND ON LOCAL CODE
- (3) THESE SYMBOLS REPRESENT A COMMON NEUTRAL / GROUND CONNECTION. **DO NOT** CONFUSE WITH GROUNDING ROD

WIRE GAUGE GUIDE (COPPER)

LABEL	CONDUCTOR
A	MAX. 4 AWG
B	MAX. 10 AWG
C	MAX. 4 AWG
D	24- 23 AWG CAT6

Diagram 06

Sol-Ark 60K-3P-480V Standard Wiring Diagram - 2 Parallel Inverters, Standard Wiring

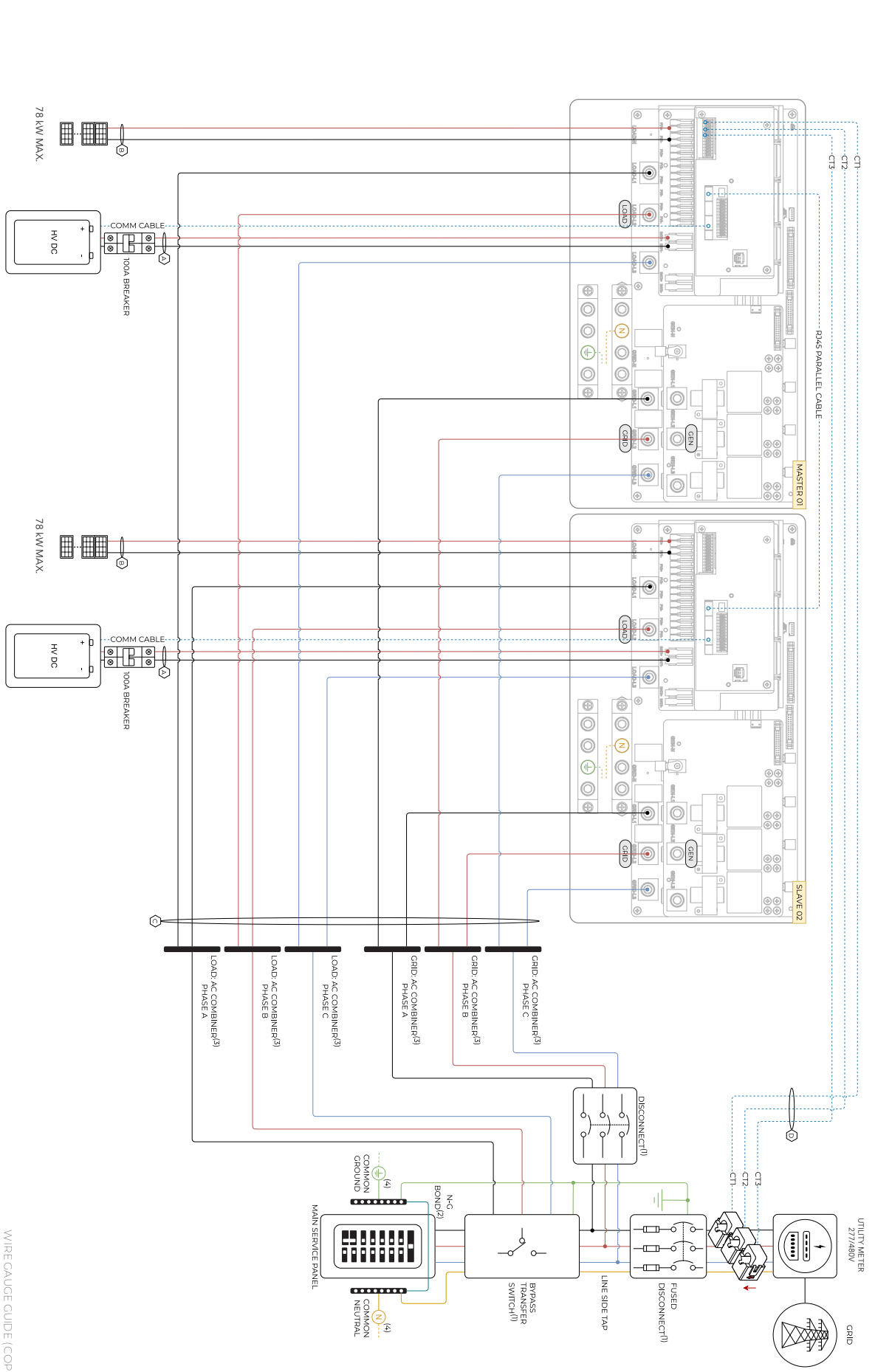

- L1 - (AC)
- NEGATIVE - (DC)
- L2 - (AC)
- POSITIVE - (DC)
- L3
- NEUTRAL
- GROUND
- SENSORS / COMMUNICATIONS

- (1) SIZE OF DISCONNECT / BYPASS SWITCH WILL DEPEND ON REQUIRED PASTTHROUGH CURRENT AND LOCAL CODE REQUIREMENTS
- (2) LOCATION OF THE NEUTRAL-GROUND BOND WILL DEPEND ON LOCAL CODE
- (3) SMALL COMBINER PANEL CAN BE USED TO COMBINE PHASES AND AS A MEAN OF INDIVIDUAL SYSTEM DISCONNECTION
- (4) THESE SYMBOLS REPRESENT A COMMON NEUTRAL / GROUND CONNECTION. **DO NOT** CONFUSE WITH GROUNDING ROD

WIRE GAUGE GUIDE (COPPER)

LABEL	CONDUCTOR
A	MAX 4 AWG
B	MAX 10 AWG
C	MAX 4 AWG
D	24-23 AWG CAT6

Diagram 07

1 Before powering up Parallel System installs, please see section 5 "Parallel Systems"

Sol-Ark 60K-3P-480V Standard Wiring Diagram - 3 Parallel Inverters, Standard Wiring

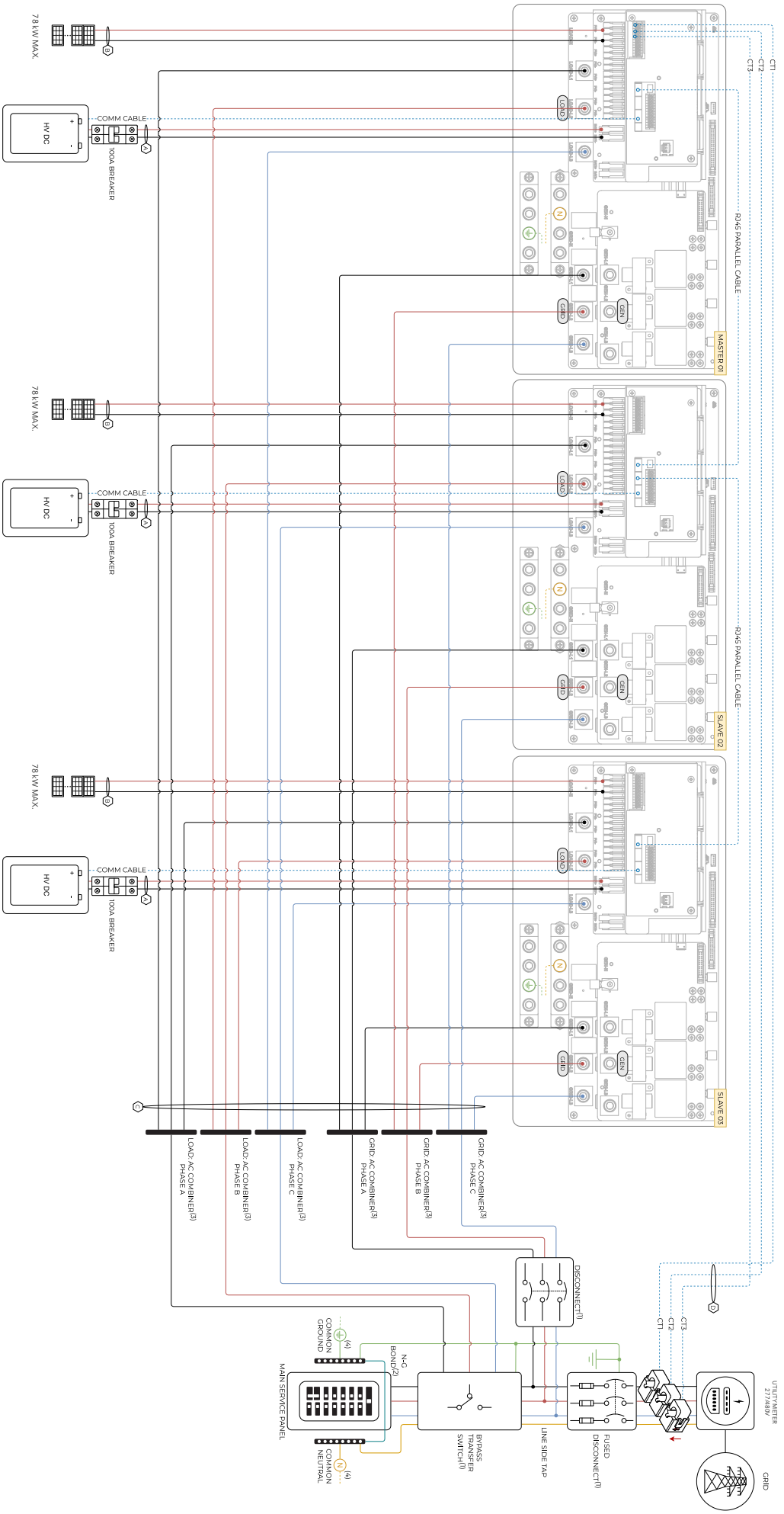

- (1) SIZE OF DISCONNECT / BYPASS SWITCH WILL DEPEND ON REQUIRED PASTHROUGH CURRENT AND LOCAL CODE REQUIREMENTS
- (2) LOCATION OF THE NEUTRAL-GROUND BOND WILL DEPEND ON LOCAL CODE
- (3) SMALL COMBINER PANEL CAN BE USED TO COMBINE PHASES AND AS A MEAN OF INDIVIDUAL SYSTEM DISCONNECT
- (4) THESE SYMBOLS REPRESENT A COMMON NEUTRAL/GROUND CONNECTION. **DO NOT** CONFUSE WITH GROUNDING ROD

WIRE GAUGE GUIDE (COPPER)

LABEL	CONDUCTOR
A	MAX. 4 AWG
B	MAX. 10 AWG
C	MAX. 4 AWG
D	24 - 23 AWG CAT6

— L1 - (AC) NEGATIVE - (DC)
— L2 - (AC) POSITIVE - (DC)
— L3
— NEUTRAL
— GROUND
— SENSORS / COMMUNICATIONS

1 Before powering up Parallel System installs, please see section 5 "Parallel Systems"

Diagram 08

8. Troubleshooting Guide

LCD is not powering on

- Check all connections - at least one of the following power sources is required: PV/Grid/Battery
- Try pressing the power button, touchscreen, or navigation buttons

Panels are connected, but "DC" LED indicator is not on

- Startup voltage is 180V. Voltage must be above 180V and below 1,000V
- Wrong polarity. Check string polarity on MPPT
- PV DC disconnect switches are not on the ON position

Panels are not producing

- Check for proper wiring on all solar panel connections
- Turn PV disconnect switches "ON"
- Check that the PV input voltage is not greater than 1,000V
- If the system measures 0V even when PV DC disconnect is ON, polarity might be wrong. Check PV polarity

Panels are not producing much power

- PV Wire Strip Length: 5/8". Your batteries are charged and is limited to house loads; you can test Grid Sell to verify.

The system does not keep batteries charged

- Verify there is proper communication between the Sol-Ark and the battery. : ⚙️ → *Li-Batt Info*
- Verify proper Charge and Voltage settings according to battery manufacturer and battery bank arrangement

Auto Gen-Start is not working

- Make sure the generator has a compatible Two-Wire
- Verify adequate connection to the Sol-Ark auto-start input pins

"Normal" LED indicator is not on

- Sol-Ark is in pass-through mode (only Grid connection and no other power source)
- Not fully energized (DC Solar panels AND Grid or batteries only)
- In alarm state.
- Sol-Ark is not working correctly (Call technical support +1 (972) 575-8875 Ext. 2)

The "Alarm" LED indicator is on

- Check the system alarms menu to identify the alarm

Grid HM value is negative when it should be positive (only applies in Limited to Home mode)

- Limiter Sensors are backwards, L1/L2/L3 sensors are swapped, or incorrectly wired. Execute the "Auto Learn Home Limit Sensors" command described in section 2.9 "Limit Sensors, Automatic CT Limit Sensors Configuration"

AC Overload Fault or Bus Unbalance Fault

- Check Transfer Switch/Subpanel wiring
- Check for large loads that consume more than the inverter rating

The system connects to grid and quickly disconnects

- Verify Neutral wire connection (0Vac referenced to GND)
- Check the programmed frequency, and verify the Sol-Ark measures 277V between L and N
- If the system is overloading: verify that proper phase sequence between "GRID" and "LOAD" terminals

DC Overload Fault

- Check PV voltage. Ensure no more than 1,000V
- Make sure you have not wired more than two (2) solar strings in parallel per MPPT

System is beeping

- Check the System Alarms menu to see which alarm has been triggered. Most alarms will self-reset
- Do a Power Cycle as described in section 2.12 "Power Cycle Sequence"

Battery cable sparks when connected

- If applicable, flip the built-in breakers of the battery bank before connecting or disconnecting batteries

Battery symbol on the home screen is red

- The battery is below the empty voltage
- Battery is over-voltage or under-voltage

Battery symbol on the home screen is yellow

- The battery is low, or the charge/discharge current is close to the programmed limit

Grid symbol on the home screen is yellow

- Grid parameters are out of specified operating range
- There is a grid outage and there is no voltage on the "GRID" terminal
- System is Off-Grid

System has restarted

- Occurs when the system has overloaded, battery voltage has surpassed 800V
- There was a Software update

Batteries were connected backwards

-  System will be damaged, and warranty will be lost

Why is the LCD screen still on when the power button is off?

- Occurs when the power button is in the "OFF" position
- Occurs when the system is not fully energized: PV or Grid only

The Batt SOC% is not reaching 100%

- BMS communication is not working properly. Verify with battery integration and communication steps

Generator setup is reading 0Hz

- Generator is operating at a frequency outside the permissible range. Select " General Standard " grid mode. Widen the frequency range to 55Hz-65Hz as described in section 2.5 "Integrating a Generator"

Color Touchscreen is Frozen

- Press and hold the escape button [] for 7-10 seconds
- Perform a power cycle sequence in case the above suggestion does not work. See section 2.12 "Power Cycle Sequence"

Grid Phase Wrong

-  If the Sol-Ark screen shows a "Grid Phase Wrong" message, it means there is a phasing issue in the wiring. If left unchecked it may cause overload faults and **DAMAGE**. See section 5.3 "Troubleshooting Phase Sequence"

8.1 Sol-Ark Error codes

FAULT	INSTRUCTION	COMMON CAUSE / REMEDY
F1	DC_Inversed_Failure	If you have parallel systems and turn one system off, you will get this notification. NOT a fault.
F8	GFDI_Relay_Failure	Check for continuity on the inverter's neutral and ground. Ensure there is only ONE neutral-to-ground bond in the system. Current Leakage from inverter AC output to Ground, check Ground and neutral are connected at the main panel.
F13	Grid_Mode_change	It can happen when not using batteries or if Grid Input settings are changed. This is a notification, NOT a fault. If you switch from No Batt to Battery mode, power the system down completely to restart.
F15	AC_OverCurr_Failure	It is usually caused by Loads too large for the inverter. If Off-Grid, the battery discharge Amps are programmed too low. Overloads can result in F15, F18, F20, or F26.
F16	GFCI_Failure	Ground fault. Check PV+ or PV- wiring (which must be ungrounded). Exposed PV conductors + rain can also cause. Check that the neutral line and Ground are not double-bonded (common with portable generators).
F18	Tz_AC_OverCurr_Fault	Overloaded the Load Output (reduce loads) or overloaded a generator (reduce Gen Start A). Wiring Short on the AC Side can also cause this error. Overloads can result in F15, F18, F20, or F26.
F20	Tz_Dc_OverCurr_Fault	It is typically caused by DC current from the battery that is too large (ex: 4 Ton AC Unit) or too much PV current (3 or more strings in parallel). Overloads can result in F15, F18, F20, or F26.
F22	Tz_EmergStop_Fault	Initiated Emergency Stop; see sensor pinout table.
F24	DC_Insulation_Fault	An exposed PV conductor combined with moisture is faulting (can cause F16, F24, and F26).
F25	DC_Feedback_Fault	No battery connection to the Inverter and Activate Battery is enabled. Disable Activate Battery in settings while no battery is connected.
F26	BusUnbalance_Fault	Too much load on one leg (L1 or L2) vs. the other leg or DC loads on the AC output when Off-Grid. Grounded PV+/- wire can cause F20, F23, or F26.
F29	Parallel_CANBus_Fault	Usually, a communication error for parallel systems. Check cables, and MODBUS addresses.
F31	Soft_Start_Failed	Soft Start of the large motor failed.
F34	AC_Overload_Fault	AC Overload or load shorted. Reduce heavy loads.
F35	AC_NoUtility_Fault	Grid connection lost.
F37	DCLLC_Soft_Over_Cur	Software DC overcurrent.
F39	DCLLC_Over_Current	Hardware DC overcurrent.
F40	Batt_Over_Current	Batteries exceeded their current discharge limit.
F41	Parallel_System_Stop_Fault	If one system faults in parallel, this normal fault will register on the other units as they disconnect from the grid.
F45	AC_UV_OverVolt_Fault	Grid under voltage causes a disconnect. This will self-reset when the grid stabilizes.
F46	Battery_Backup_Fault	Cannot communicate with other parallel systems. Check Master = 1, Slaves = 2-9 and that ethernet are connected.
F47	AC_OverFreq_Fault	Grid over Frequency (common in power outages) causes disconnect. Will self-reset when grid stabilizes.
F48	AC_UnderFreq_Fault	Grid under Frequency (common in power outages) causes a disconnect. Will self-reset when grid stabilizes.
F55	DC_VoltHigh_Fault	PV may be higher than 500V. Battery voltage should not be above 59V or 63V (depending on the model).
F56	DC_VoltLow_Fault	Batteries are overly discharged, the inverter is Off-Grid and exceeded the programmed batt discharge current by 20%, or Lithium BMS has shut down. If battery settings are incorrect, this can also happen.
F58	BMS_Communication Fault	Sol-Ark is programmed to BMS Lithium Battery Mode but cannot communicate with a BMS. BMS_Err_Stop is enabled, but cannot communicate with a battery BMS
F60	Gen_Volt_or_Fre_Fault	Generator Voltage or Frequency went outside the allowable range.
F61	Button_Manual_OFF	The parallel Slave system turned off without turning off the Master.
F63	Arc_Fault	It can be a poor PV connector / Connection. Or sometimes a false alarm due to powerful lightning storms.
F64	Heatsink_HighTemp_Fault	Check that the built-in fans are running; the ambient temperature may be too high. Ensure proper clearance.

9. Warranty Verification Checklist

MUST complete this form **AFTER** the system is operational. To register the product warranty, this verification checklist must be filled out and submitted to Sol-Ark. Visit <https://www.sol-ark.com/register-your-sol-ark/> to register warranty.



Installer/Company: _____ Date: (YYYY-MM-DD) _____

Inverter SN: _____ Gateway SN: _____

Mark ✓ for all that apply

Indicate the type of system (all that apply):

Grid-Tied only | Grid-Tied with battery backup | Off-Grid | Parallel system: # _____ inverters

Indicate integrated components (all that apply):

<input type="checkbox"/> Utility grid	<input type="checkbox"/> DC solar panels	<input type="checkbox"/> AC coupled solar panels	<input type="checkbox"/> Generator
<input type="checkbox"/> "LOAD" installed service panel	<input type="checkbox"/> "GRID" installed service panel	<input type="checkbox"/> "GEN" installed service panel	<input type="checkbox"/> Lithium batteries
<input type="checkbox"/> Lead-Acid batteries	<input type="checkbox"/> Wind Turbine		

⚠ It is strongly recommended to send a **Wiring Diagram** of the installation to support@sol-ark.com for verification, otherwise Sol-Ark expressly disclaims any responsibility for performance issues arising from improper installation. Installers and users are solely responsible for following proper installation procedures outlined in provided documentation. Sol-Ark disclaims any liability for changes in the installation that might result in electrical malfunctions or any other issues related to the Sol-Ark product.

! Circle **N/A (Not Applicable)** if the verification step is not relevant to the type of system or does not apply to the integrated components.

1. A wiring diagram of the installation was sent to Sol-Ark for verification	<input type="checkbox"/> Y	<input type="checkbox"/> N
2. Setup for remote system monitoring through Wi-Fi / Ethernet is completed. Gateway SN: _____	<input type="checkbox"/> Y	<input type="checkbox"/> N
3. The inverter is installed in a location where the LCD screen is always protected from direct sunlight	<input type="checkbox"/>	
4. The inverter has the minimum specified vertical and lateral clearance for proper heat dissipation	<input type="checkbox"/>	
5. The maximum DC input voltage does not surpass 1,000V _{DC}	<input type="checkbox"/>	
6. The HV Battery bank does not surpass 800V _{DC}	<input type="checkbox"/>	
7. All battery conductors are properly connected and secured to the (+, -) terminals of the inverter	<input type="checkbox"/>	N/A
8. Battery communication was successfully established	<input type="checkbox"/>	N/A
9. All Battery Setup parameters are programmed according to battery manufacturer specifications	<input type="checkbox"/>	N/A
10. The Sol-Ark properly generates power from the solar panels to charge the batteries	<input type="checkbox"/>	N/A
11. Grid / Generator is properly connected to the Sol-Ark and the phase sequence was verified	<input type="checkbox"/>	N/A
12. <input checked="" type="checkbox"/> "Grid / Gen Charge" settings are programmed correctly. Grid / Generator adequately charge the batteries	<input type="checkbox"/>	N/A
13. For Off-Grid systems: The mode "General Standard" is programmed and the V & f ranges are increased	<input type="checkbox"/>	N/A
14. When <input checked="" type="checkbox"/> "Grid Sell" is enabled, the Sol-Ark sells power back to the grid (negative HM measurements for L1, L2, L3)	<input type="checkbox"/>	N/A
15. Limit sensors are correctly installed on Grid lines / Generator lines	<input type="checkbox"/>	N/A
16. Only when <input checked="" type="checkbox"/> "Limited Power to Home" is enabled, the Sol-Ark matches total load demand (Meter Zero)	<input type="checkbox"/>	N/A
17. Disconnect the grid: during Off-Grid operation, the inverter properly supplies "LOAD" demand for PV and batteries	<input type="checkbox"/>	N/A
18. Disconnect the grid AND solar panels: during Off-Grid operation, the inverter properly draws power from batteries	<input type="checkbox"/>	N/A

In the event of system-related issues, forward a comprehensive description of the problem via email to support@sol-ark.com. Ensure the addition of images, including the "Details Screen" with all electrical measurements, as well as images of the inverter, wiring configuration, user area, batteries, and any other integral components constituting the power system.

Installer name and signature

Customer name and signature

Date

Limited Warranty: Sol-Ark 60K-3P-480V

10-Year Limited Warranty for **Sol-Ark LLC** Products. Sol-Ark LLC provides a Ten-year (10) limited Warranty ("Warranty") against defects in materials and workmanship for its Sol-Ark LLC products ("Product"). The term of this warranty begins on the Product(s) initial purchase date, or the date of receipt of the Product(s) by the end user, whichever is later. This must be indicated on the invoice, bill of sale from your installer. This warranty applies to the original Sol-Ark LLC Product purchaser and is transferable only if the Product remains installed in the original use location. Please call Sol-Ark LLC to let us know if you are selling your Home and give us name and contact of the new owner.

Contact: (USA) +1-972-575-8875

For Info/Purchasing:

sales@sol-ark.com | ext.1

For Tech Support/Warranty Claim:

support@sol-ark.com | ext.2

The warranty does not apply to any Product or Product part that has been modified or damaged by the following:

- Installation or Removal (examples: wrong voltage batteries, connecting batteries backward, damage due to water/rain to electronics, preventable damage to solar wires.)
- Alteration or Disassembly.
- Normal Wear and Tear.
- Accident or Abuse.
- Unauthorized Firmware updates/software updates or alterations to the software code.
- Corrosion.
- Lightning: unless using EMP hardened system, then Sol-Ark LLC will repair the product.
- Repair or service provided by an unauthorized repair facility.
- Operation or installation contrary to manufacturer product instructions.
- Fire, Floods, or Acts of Nature.
- Shipping or Transportation.
- Incidental or consequential damage caused by other components of the power system.
- Any product whose serial number has been altered, defaced, or removed.
- Any other event not foreseeable by Sol-Ark LLC

Sol-Ark LLC liability for any defective Product, or any Product part, shall be limited to the repair or replacement of the Product, at Sol-Ark LLC discretion. Sol-Ark LLC does not warrant or guarantee workmanship performed by any person or firm installing its Products. This warranty does not cover the costs of installation, removal, shipping (except as described below), or reinstallation of Products or parts of Products. LCD screen and fans are covered for 5 years from date of purchase.

THIS LIMITED WARRANTY IS THE EXCLUSIVE WARRANTY APPLICABLE TO SOL-ARK LLC PRODUCTS. SOL-ARK LLC EXPRESSLY DISCLAIMS ANY OTHER EXPRESS OR IMPLIED WARRANTIES OF ITS PRODUCTS. SOL-ARK LLC ALSO EXPRESSLY LIMITS ITS LIABILITY IN THE EVENT OF A PRODUCT DEFECT TO REPAIR OR REPLACEMENT IN ACCORDANCE WITH THE TERMS OF THIS LIMITED WARRANTY AND EXCLUDES ALL LIABILITY FOR INCIDENTAL OR CONSEQUENTIAL DAMAGES, INCLUDING WITHOUT LIMITATION ANY LIABILITY FOR PRODUCTS NOT BEING AVAILABLE FOR USE OR LOST REVENUES OR PROFITS, EVEN IF IT IS MADE AWARE OF SUCH POTENTIAL DAMAGES.

Return Policy - No returns will be accepted without prior authorization and must include the Return Material Authorization (RMA) number. Please call and talk to one of our engineers to obtain this number at 972-575-8875.

Return Material Authorization (RMA) A request for an RMA number requires all the following information: 1. Product model and serial number; 2. Proof-of-purchase in the form of a copy of the original Product purchase invoice or receipt confirming the Product model number and serial number; 3. Description of the problem; 4. Validation of problem by Technical Support, and 5. Shipping address for the repaired or replacement equipment. Upon receiving this information, the Sol-Ark LLC representative can issue an RMA number. Any product that is returned must be brand new, in excellent condition and packaged in the original manufacturer's carton with all corresponding hardware and documentation. Returns must be shipped with prepaid freight and insured via the carrier of your choice to arrive back at Sol-Ark LLC within 30 days of your initial delivery or pick-up. **Shipping charges will not be refunded.** All returns are subject to a 35% restocking fee. **No returns will be accepted beyond 30 days of original delivery.** The value and cost of replacing any items missing (parts, manuals, etc.) will be deducted from the refund. If you have any questions regarding our return policy, please email us at sales@sol-ark.com or call us at the number above during regular (Monday to Friday) business hours.

Sol-Ark 60K-3P-480V Install Operational Verification Checklist Questionnaire must be filled out, signed, and dated to secure full warranty coverage.

10. GUI Screens

1. Main Menu

The Main Menu displays system status and production metrics. It includes a 'Solar Today' and 'Total' KWH section with icons for solar, grid, and battery. Below are four circular gauges for power output in KW. A 'System Alarms' table lists recent events. A central table shows real-time data for Solar, Grid, INV, USP LD, and Batt. A 'System Setup' menu offers options like Basic Setup, System Alarms, Battery Setup, Li-Batt Info, Limiter, and Grid Setup. A detailed battery status table is also present.

Alarms Code	Occurred
F13 Grid_Mode_changed	2021-01-13 11:22
F13 Grid_Mode_changed	2021-01-13 11:20

Solar	Grid	INV	USP LD	Batt
0W	0Hz	60.0Hz	L1: 0V	0.0V/ 0%
0V/0.5A			L2: 0V	0.00A
M1: 0W	L1: 0V	L1: 0V	L3: 0V	0.0C
364V/0.0A	L2: 0V	L2: 0V	L1: 0W	0.00V/ 0%
M2: 0W	L3: 0V	L3: 0V	L2: 0W	0.00A
0V/0.1A			L3: 0W	0.0C
M3: 0W	HM1: 0W	L1: 0A	Gen 60.0Hz 0W	
362V/0.8A	HM2: 0W	L2: 0A	L1: 0V	L1: 0W
M4: 0W	HM3: 0W	L3: 0A	L2: 0V	L2: 0W
			L3: 0V	L3: 0W

AC:19.4C	LD1: 0W	L1: 0W	L1: 0W
	LD2: 0W	L2: 0W	L2: 0W
	LD3: 0W	L3: 0W	L3: 0W

0.00 V	0.00 A	0.0 C	0%	0 Ah
0.0 V	0.0 V	0A	0A	0x00 0x00

Only w/ BMS Lithium Mode

1. 0.00V 0.00A 0.0C 0.0%	0.0V 0.0A 0.0C
2. 0.00V 0.00A 0.0C 0.0%	0.0V 0.0A 0.0C
3. 0.00V 0.00A 0.0C 0.0%	0.0V 0.0A 0.0C
4. 0.00V 0.00A 0.0C 0.0%	0.0V 0.0A 0.0C
5. 0.00V 0.00A 0.0C 0.0%	0.0V 0.0A 0.0C
6. 0.00V 0.00A 0.0C 0.0%	0.0V 0.0A 0.0C
7. 0.00V 0.00A 0.0C 0.0%	0.0V 0.0A 0.0C
8. 0.00V 0.00A 0.0C 0.0%	0.0V 0.0A 0.0C
9. 0.00V 0.00A 0.0C 0.0%	0.0V 0.0A 0.0C
10. 0.00V 0.00A 0.0C 0.0%	0.0V 0.0A 0.0C
11. 0.00V 0.00A 0.0C 0.0%	0.0V 0.0A 0.0C
12. 0.00V 0.00A 0.0C 0.0%	0.0V 0.0A 0.0C
13. 0.00V 0.00A 0.0C 0.0%	0.0V 0.0A 0.0C

2. Basic Setup

The Basic Setup screen is divided into several tabs: Display, Time, Advanced, Factory Reset, and Parallel. The 'Display' tab shows brightness and beep settings. The 'Time' tab allows setting AM/PM, time sync, and seasons. The 'Advanced' tab includes solar arc fault, power limits, and auto-detect options. The 'Factory Reset' tab has checkboxes for system checks and locks. The 'Parallel' tab configures master/slave modes and metering.

3. Batt Setup

Batt Setup

Batt | Charge | Discharge | Smart Load

Batt capacity: 200Ah BMS Lithium Batt 01

Max A charge: 50A Use Batt V charged

Max A discharge: 50A No Battery

Parallel Batt 1&2

CANCEL OK

Batt Setup

Batt | Charge | Discharge | Smart Load

StartV: 490.0V | 490.0V | Float V: 552.0V

Start%: 30% | 30%

A: 40A | 40A

Gen-Charge Grid Charge

Gen Force CANCEL OK

Batt Setup

Batt | Charge | Discharge | Smart Load

Shutdown: 170.0V | 10%

Low Batt: 165.0V | 20%

Restart: 180.0V | 50%

Batt Empty V: 160.0V BMS_Evt_Stop

CANCEL OK

Batt Setup

Batt | Charge | Discharge | Smart Load

Use gen input as load output For AC Coupled input to Gen

On Grid always on High-Frq: 65.00Hz

Smart Load-OFF Batt: 530.0V | 95%

Smart Load-ON Batt: 540.0V | 100%

CANCEL OK

4. Limiter

Grid Param

Limitier | Other

	Time	Power(W)	Batt	Charge	Sell
<input type="checkbox"/> Grid Sell	60000				
<input type="checkbox"/> Limited Power to Home	01:00AM	2000	50%		
<input type="checkbox"/> Limited Power to Home	05:00AM	2000	50%		
<input checked="" type="checkbox"/> Limited Power to Load	09:00AM	2000	100%		
<input type="checkbox"/> Limited Power to Load	01:00PM	2000	100%		
<input type="checkbox"/> Time of Use	05:00PM	2000	50%		
<input type="checkbox"/> Time of Use	09:00PM	2000	50%		

CANCEL OK

Grid Param

Time of Use Setup

Mon. Tues. Wed. Thur.

Fri. Sat. Sun.

Season1 Season2 Season3

CANCEL OK

Grid Param

Limitier | Other

GEN connect to Grid Input

Zero Export Power: 10W

Batt First Load First

CANCEL OK

5. Grid Setup

Grid Param

Grid Selection | Connect | IP | F(W) | V(W)/V(Q) | P(Q)/P(F)

Grid Mode: 1/3

Grid Frequency: 50Hz

Grid Reconnect Time: 300s

Grid Level: LN 277V/LL 480V/AC

Phase Type: 0/240/120

CANCEL OK

Grid Param

Grid Selection | Connect | IP | F(W) | V(W)/V(Q) | P(Q)/P(F)

Reconnect

Grid Vol High	504.0V
Grid Vol Low	422.4V
Grid Hz High	60.1Hz
Grid Hz Low	59.5Hz
Reconnect Ramp rate	300s

Normal connect

Grid Vol High	576.0V
Grid Vol Low	240.0V
Grid Hz High	65.0Hz
Grid Hz Low	50.0Hz
Normal Ramp rate	300s

CANCEL OK

Grid Param

Grid selection | Connect | IP | F(W) | V(W)/V(Q) | P(Q)/P(F)

Over Voltage U-(10 min. running mean): 239.2V

HV3	576.0V		HF3	65.00Hz
HV2	576.0V	0.16s	HF2	65.00Hz
HV1	528.0V	13.00s	HF1	63.00Hz
LV1	422.4V	21.00s	LF1	57.00Hz
LV2	240.0V	2.00s	LF2	50.00Hz
LV3	240.0V		LF3	50.00Hz

CANCEL OK

Grid Param

Grid selection | Connect | IP | F(W) | V(W)/V(Q) | P(Q)/P(F)

Over frequency

Start freq F	60.04Hz
Start delay	0.50s

Droop F: 42%PE/Hz

Stop freq F: 60.04Hz

Stop delay: 0.50s

Under frequency

Start freq F>	59.96Hz
Start delay F>	0.50s

Droop F>: 42%PE/Hz

Stop freq F>: 59.96Hz

Stop delay F>: 0.50s

CANCEL OK

Grid Param

Grid selection | Connect | IP | F(W) | V(W)/V(Q) | P(Q)/P(F)

V(W) V(Q)

Response_T: 55

V1:106.0%	P1:100%	V1:92.0%	Q1:44%
V2:110.0%	P2:0%	V2:98.0%	Q2:0%
V3:110.0%	P3:0%	V3:100.0%	Q3:0%
V4:110.0%	P4:0%	V4:106.0%	Q4:44%

CANCEL OK

Grid Param

Grid selection | Connect | IP | F(W) | V(W)/V(Q) | P(Q)/P(F)

P(Q) P(F)

P1:20%	Q1:100%	P1:50.0%	F1:1.000
P2:50%	Q2:100%	P2:100.0%	F2:0.800
P3:100%	Q3:100%	P3:100.0%	F3:0.800
P4:100%	Q4:100%	P4:100.0%	F4:0.800

CANCEL OK

